

博雅I系列

三谷照明磁吸组合照明系统

产品概览-博雅I系列磁吸组合照明系统

轨道

常规系列

预埋式



SG-GD4820Y/L1000



SG-GD4822Y/L1000

表面
嵌入式



SG-GD4520Q/L1000



SG-GD2620Q/L1000

悬挂/
吸顶式



SG-GD2120D/L1000

灯具

射灯



SG-ZCSD2265/1W



SG-ZCSD2265/3W



SG-ZCSD3463/5W

吊线灯



SG-ZCDX25150/5W



SG-ZCDX25200/5W

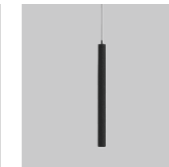

SG-ZCDX25300/5W



SG-ZCDX6068/5W

格栅
线性灯



SG-ZCGS1552/L211/T5W



SG-ZCGS1552/L283/T7W



SG-ZCGS1511/L72/2W



SG-ZCGS1511/L211/5W



SG-ZCGS1511/L355/10W



SG-ZCGS1511/L499/15W



SG-ZCGS1511/L715/20W



SG-ZCGS1511/L1003/30W

平面
线性灯



SG-ZCPM1552/L211/T5W



SG-ZCPM1552/L283/T7W



SG-ZCPM1511/L268/2W

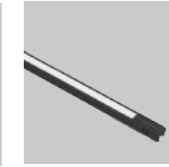

SG-ZCPM1511/L468/4W



SG-ZCPM1511/L668/6W



SG-ZCPM1511/L868/8W



SG-ZCPM1511/L1068/10W



博雅I系列预埋式轨道

产品型号: SG-GD4820Y/L1000
 安装方式: 预埋式
 产品尺寸: W48*H20mm
 标准规格: L1000/1500/2000mm
 控制方式: 单组控制
 材 质: 6063铝
 外观颜色: 砂黑/砂白
 防护等级: IP20
 预埋槽尺寸: W25*H20mm (长度按轨道而定)
 天花板层厚: 9mm

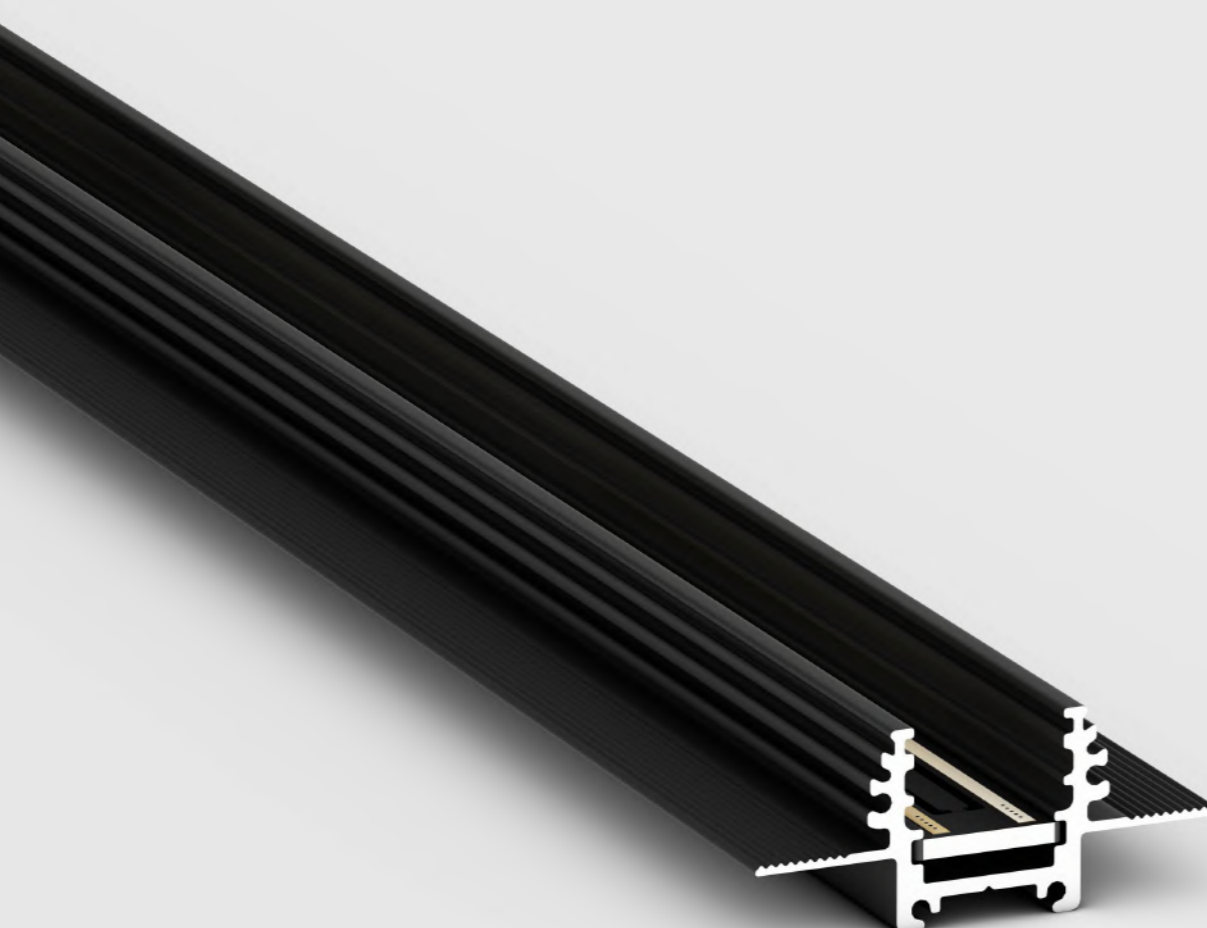
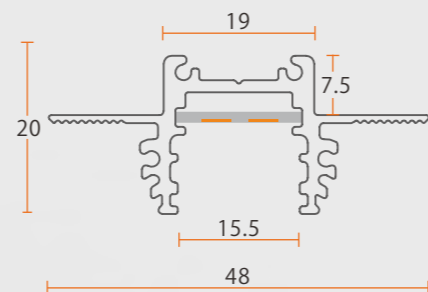

安装方式

表面嵌入式

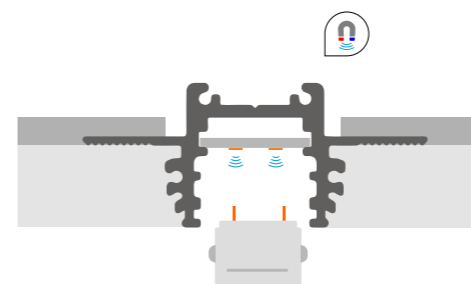

安装方式详见安装说明
 轨道与灯具之间用磁吸
 加机械卡扣方式锁死, 更加牢固

适用配件

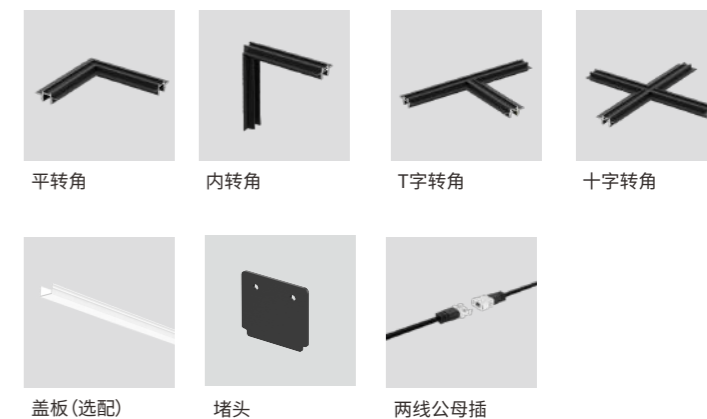

适用灯具

适用所有博雅A系列轨道



博雅I系列可调预埋式轨道

产品型号:SG-GD4822Y/L1000
 安装方式:预埋式
 产品尺寸:W48*H22mm
 标准规格:L1000/1500/2000mm
 控制方式:单组控制
 材 质:6063铝
 外观颜色:砂黑/砂白
 防护等级:IP20
 预埋槽尺寸:W30*H20mm (长度按轨道而定)
 天花板层厚:9-12mm

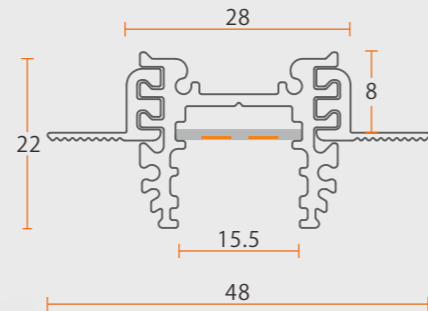

在有限的空间中, 筑造出无限艺术光影
 是我们的追求



安装方式

表面嵌入式

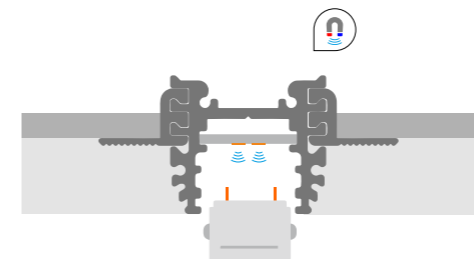

天花板厚度9mm板

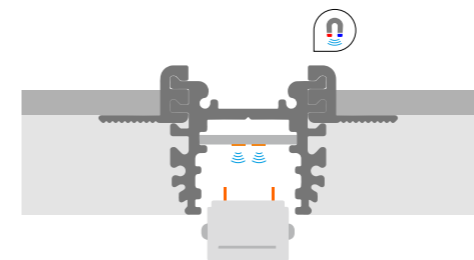

天花板厚度12mm板

安装方式详见安装说明
 轨道与灯具之间用磁吸
 加机械卡扣方式锁死, 更加牢固

适用配件



适用灯具

适用所有博雅A系列轨道



博雅I系列无边框表面嵌入式轨道

产品型号:SG-GD4520Q/L1000
 安装方式:无边嵌入式
 产品尺寸:W45*H20mm
 标准规格:L1000/1500/2000mm
 控制方式:单组控制
 材 质 :6063铝
 外观颜色:砂黑/砂白
 防护等级:IP20
 预埋槽尺寸:W25*H30mm (长度按轨道而定)
 天花板层厚:9mm

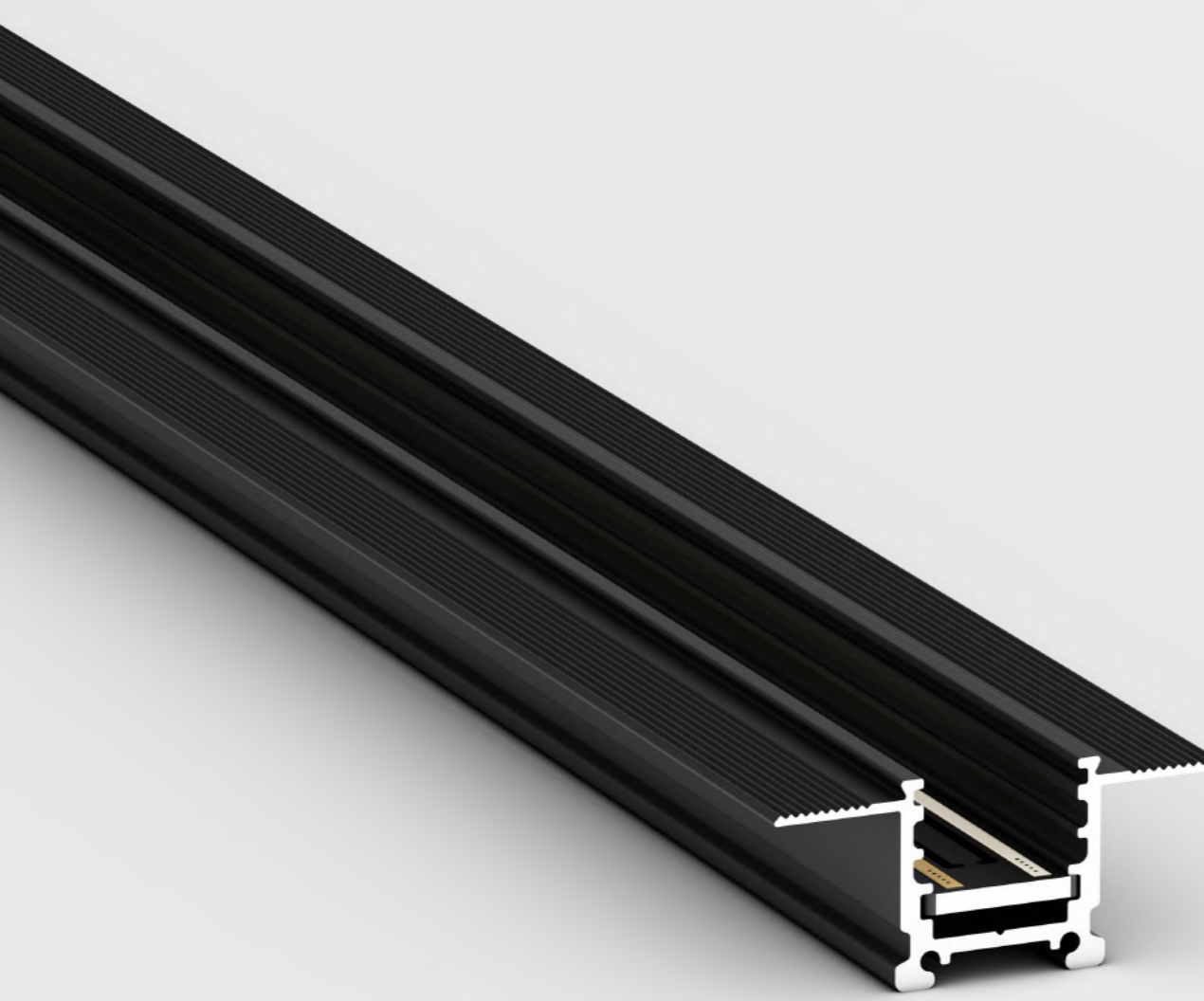
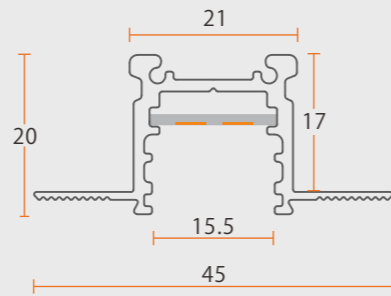

低楼层推荐

比常规款轨道,减少更多的层高占用



安装方式

表面嵌入式

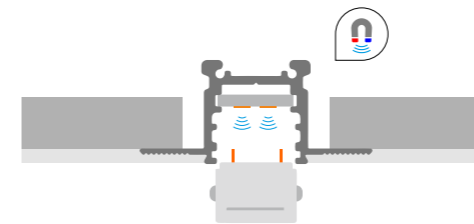

安装方式详见安装说明
 轨道与灯具之间用磁吸
 加机械卡扣方式锁死,更加牢固

适用配件



适用灯具

适用所有博雅A系列轨道



柜子·磁吸灯组合

打造温馨整洁的家

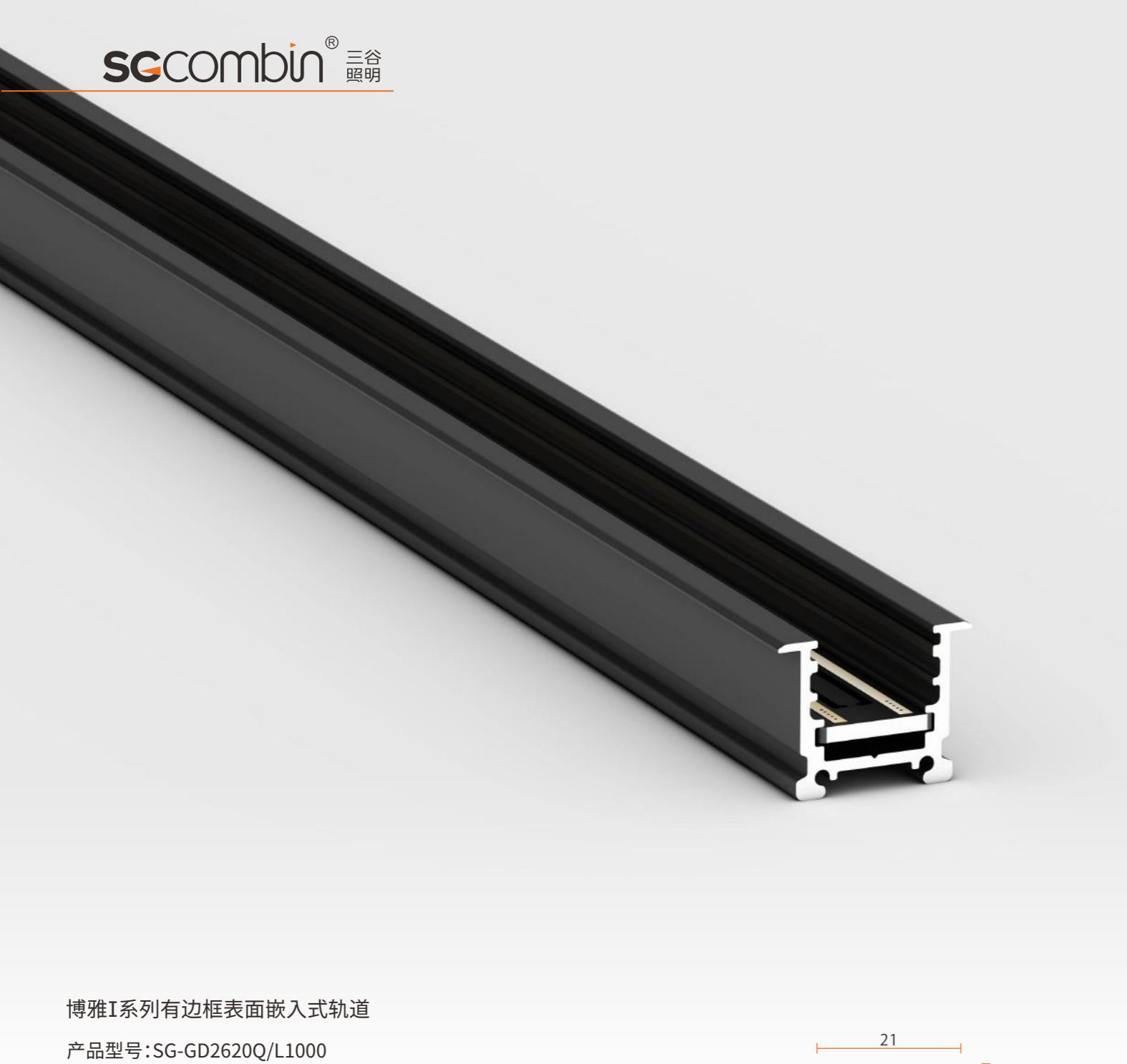
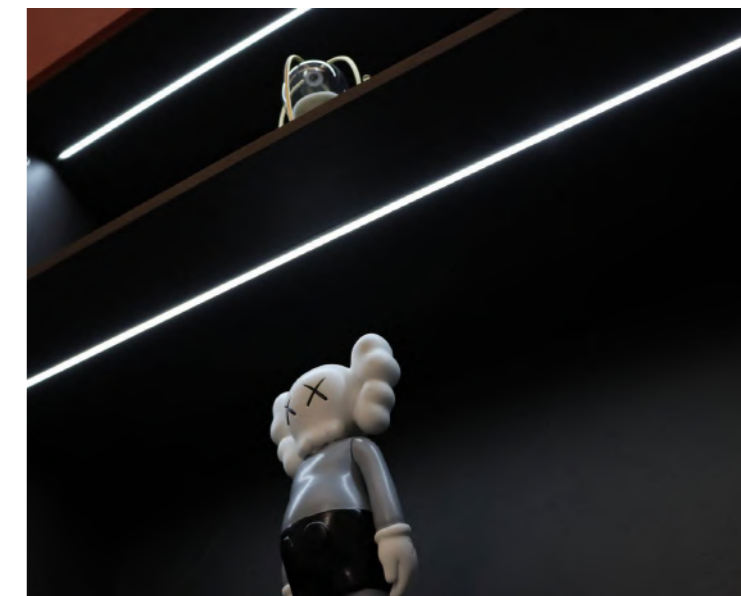

博雅I系列有边框表面嵌入式轨道

产品型号:SG-GD2620Q/L1000
 安装方式:有边嵌入式
 产品尺寸:W26*H20mm
 标准规格:L1000/1500/2000mm
 控制方式:单组控制
 材质:6063铝
 外观颜色:砂黑/砂白
 防护等级:IP20
 预埋槽尺寸:W22*H30mm(长度按轨道而定)
 天花板层厚:9mm

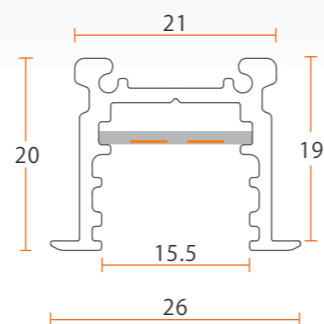

安装方式

表面嵌入式

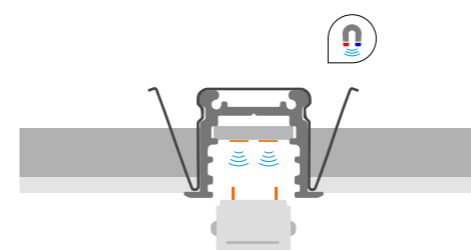

安装方式详见安装说明
 轨道与灯具之间用磁吸
 加机械卡扣方式锁死, 更加牢固

适用配件

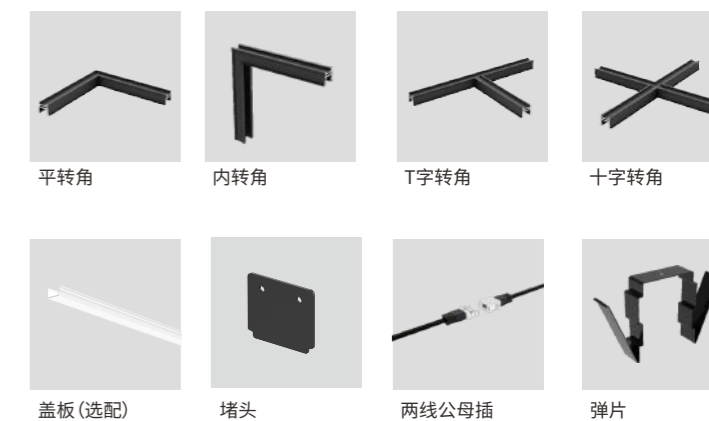

平转角 内转角 T字转角 十字转角
 盖板(选配) 堵头 两线公母插 弹片

适用灯具

适用所有博雅A系列轨道



射灯 吊线灯 可调格栅灯 可调平面线性灯
 平面线性灯 格栅线性灯



博雅I系列明装轨道

产品型号:SG-GD2120D/L1000
 安装方式:明装式
 产品尺寸:W21*H20mm
 标准规格:L1000/1500/2000mm
 控制方式:单组控制
 材 质:6063铝
 外观颜色:砂黑/砂白
 防护等级:IP20

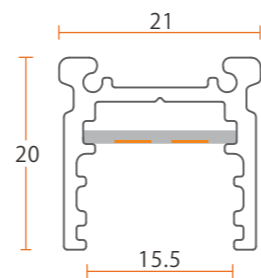

告别复杂、厚重感

隐匿于无形,尽显无主灯极简风范



安装方式

悬挂/吸顶式

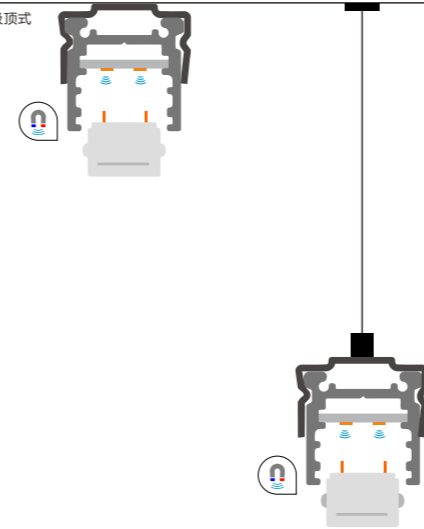

安装方式详见安装说明
 轨道与灯具之间用磁吸
 加机械卡扣方式锁死,更加牢固

适用配件



适用灯具

适用所有博雅A系列轨道



展陈系列灯具通用博雅系列

射灯

产品型号: SG-ZCSD2265/1W
 产品尺寸: Ø22*L65mm
 材 质: 6063铝
 外观颜色: 砂黑/砂白
 防护等级: IP20
 调 光: 支持
 光 源: Osram/普瑞
 电 压: DC24V
 功 率: 1W
 色 温: 2700K/3000K/4000K
 CRI : ≥90
 光 束角: 15°/24°

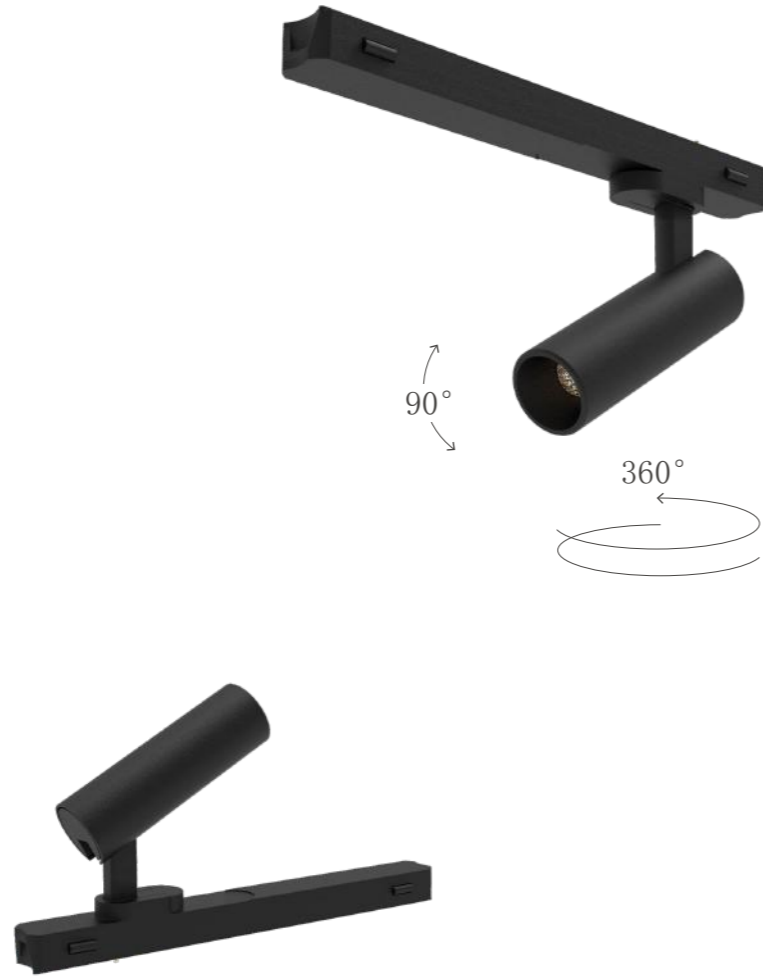

适用轨道 (博雅I全系列轨道)

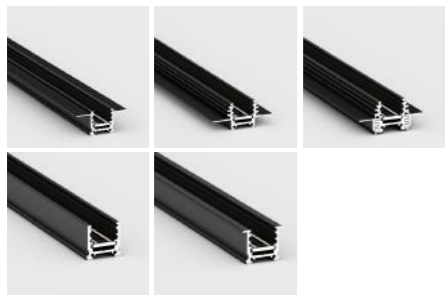

轨道截面图 (mm)

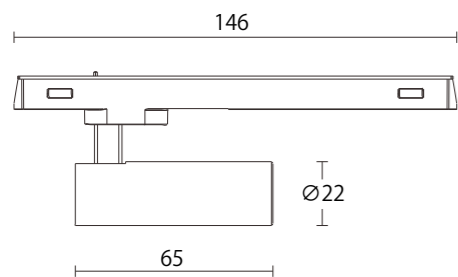

光学参数

光束角	15°	24°																														
光通量	63.145 lm	60.83																														
照度距离关系	<table border="1"> <thead> <tr> <th>h(m)</th> <th>E0°(lx)</th> <th>ø(m)</th> </tr> </thead> <tbody> <tr><td>1.50</td><td>165.65</td><td>0.53</td></tr> <tr><td>2.25</td><td>85.69</td><td>0.79</td></tr> <tr><td>3.50</td><td>32.68</td><td>1.24</td></tr> <tr><td>4.00</td><td>24.36</td><td>1.41</td></tr> </tbody> </table>	h(m)	E0°(lx)	ø(m)	1.50	165.65	0.53	2.25	85.69	0.79	3.50	32.68	1.24	4.00	24.36	1.41	<table border="1"> <thead> <tr> <th>h(m)</th> <th>E0°(lx)</th> <th>ø(m)</th> </tr> </thead> <tbody> <tr><td>1.50</td><td>128.62</td><td>0.62</td></tr> <tr><td>2.25</td><td>60.35</td><td>0.93</td></tr> <tr><td>3.50</td><td>25.46</td><td>1.45</td></tr> <tr><td>4.00</td><td>17.69</td><td>1.65</td></tr> </tbody> </table>	h(m)	E0°(lx)	ø(m)	1.50	128.62	0.62	2.25	60.35	0.93	3.50	25.46	1.45	4.00	17.69	1.65
h(m)	E0°(lx)	ø(m)																														
1.50	165.65	0.53																														
2.25	85.69	0.79																														
3.50	32.68	1.24																														
4.00	24.36	1.41																														
h(m)	E0°(lx)	ø(m)																														
1.50	128.62	0.62																														
2.25	60.35	0.93																														
3.50	25.46	1.45																														
4.00	17.69	1.65																														

光强分布曲线 (单位: cd)

C0/C180: —
 C90/C270: —

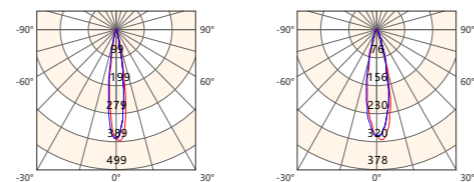

射灯

产品型号: SG-ZCSD2265/3W
 产品尺寸: Ø22*L65mm
 材 质: 6063铝
 外观颜色: 砂黑/砂白
 防护等级: IP20
 调 光: 支持
 光 源: Osram/普瑞
 电 压: DC24V
 功 率: 3W
 色 温: 2700K/3000K/4000K
 CRI : ≥90
 光 束角: 15°/24°

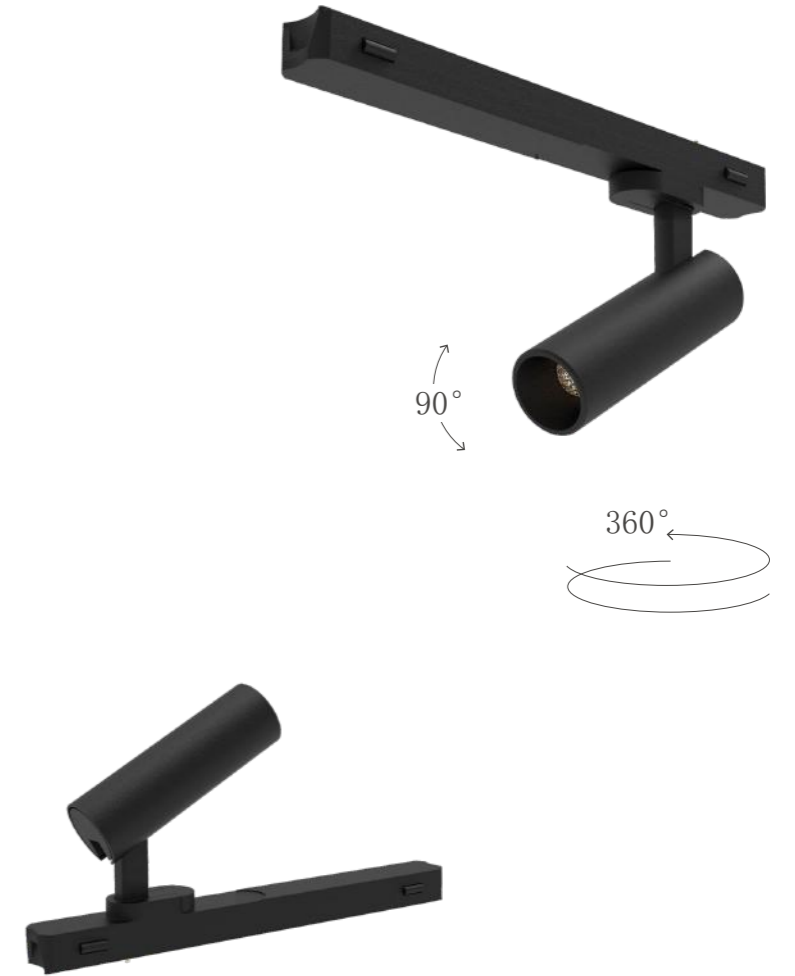

适用轨道 (博雅I全系列轨道)

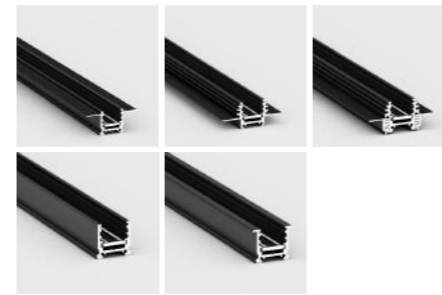

轨道截面图 (mm)

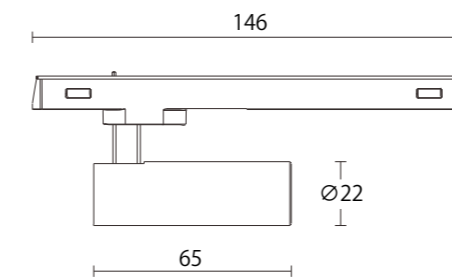

光学参数

光束角	15°	24°																														
光通量	246.3 lm	166.6 lm																														
照度距离关系	<table border="1"> <thead> <tr> <th>h(m)</th> <th>E0°(lx)</th> <th>ø(m)</th> </tr> </thead> <tbody> <tr><td>1.50</td><td>773.66</td><td>0.41</td></tr> <tr><td>2.25</td><td>343.85</td><td>0.61</td></tr> <tr><td>3.50</td><td>142.10</td><td>0.95</td></tr> <tr><td>4.00</td><td>108.80</td><td>1.08</td></tr> </tbody> </table>	h(m)	E0°(lx)	ø(m)	1.50	773.66	0.41	2.25	343.85	0.61	3.50	142.10	0.95	4.00	108.80	1.08	<table border="1"> <thead> <tr> <th>h(m)</th> <th>E0°(lx)</th> <th>ø(m)</th> </tr> </thead> <tbody> <tr><td>1.50</td><td>328.86</td><td>0.60</td></tr> <tr><td>2.25</td><td>146.16</td><td>0.90</td></tr> <tr><td>3.50</td><td>60.40</td><td>1.40</td></tr> <tr><td>4.00</td><td>46.25</td><td>1.60</td></tr> </tbody> </table>	h(m)	E0°(lx)	ø(m)	1.50	328.86	0.60	2.25	146.16	0.90	3.50	60.40	1.40	4.00	46.25	1.60
h(m)	E0°(lx)	ø(m)																														
1.50	773.66	0.41																														
2.25	343.85	0.61																														
3.50	142.10	0.95																														
4.00	108.80	1.08																														
h(m)	E0°(lx)	ø(m)																														
1.50	328.86	0.60																														
2.25	146.16	0.90																														
3.50	60.40	1.40																														
4.00	46.25	1.60																														

光强分布曲线 (单位: cd)

C0/C180: —
 C90/C270: —

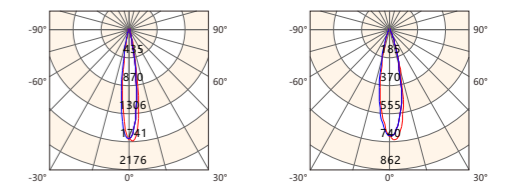

展陈系列灯具通用博雅系列

射灯

产品型号: SG-ZCSD3463/5W
 产品尺寸: Ø34*L63mm
 材 质: 6063铝
 外观颜色: 砂黑/砂白
 防护等级: IP20
 调 光: 支持
 光 源: Osram/普瑞
 电 压: DC24V
 功 率: 5W
 色 温: 2700K/3000K/4000K
 CRI : ≥90
 光 束角: 15°/24°/38°



适用轨道 (博雅I全系列轨道)

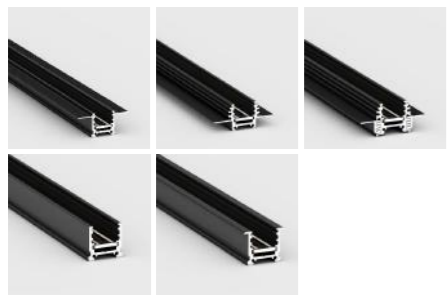

轨道截面图 (mm)

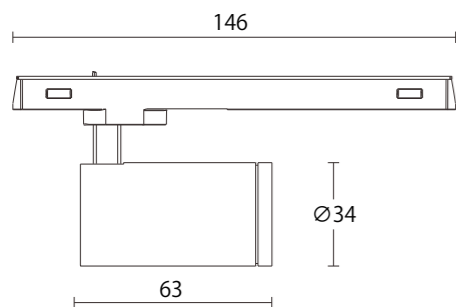

光学参数

光束角	15°	24°	38°
-----	-----	-----	-----

光通量	345.3 lm	403.8 lm	258.5 lm
-----	----------	----------	----------

照度距离关系

h(m)	E0°(lx)	ø(m)	h(m)	E0°(lx)	ø(m)	h(m)	E0°(lx)	ø(m)
1.50	1018.54	0.56	1.50	535.86	0.64	1.50	196.43	1.16
2.25	452.69	0.84	2.25	238.16	0.96	2.25	87.30	1.75
3.50	187.08	1.30	3.50	98.42	1.49	3.50	36.08	2.72
4.00	143.23	1.48	4.00	75.36	1.71	4.00	27.62	3.11

光强分布曲线 (单位: cd)

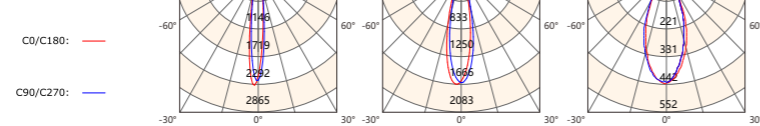

吊线灯

产品型号:SG-ZCDX25150/5W
 产品尺寸:∅25*L150mm
 材 质:6063铝
 外观颜色:砂黑色/砂白色
 防护等级:IP20
 调 光:支持
 光 源:Honourtek/Luminus
 电 压:DC24V
 功 率:1W/3W/5W
 色 温:2700K/3000K/4000K
 CRI :≥90
 光 束 角:15°/24°/38°



吊线灯

产品型号:SG-ZCDX25200/5W
 产品尺寸:∅25*L200mm
 材 质:6063铝
 外观颜色:砂黑色/砂白色
 防护等级:IP20
 调 光:支持
 光 源:Honourtek/Luminus
 电 压:DC24V
 功 率:1W/3W/5W
 色 温:2700K/3000K/4000K
 CRI :≥90
 光 束 角:15°/24°/38°



适用轨道 (博雅I全系列轨道)

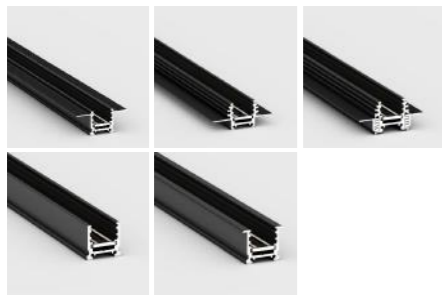

轨道截面图 (mm)

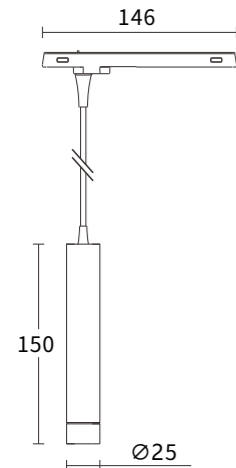

光学参数

光束角	15°	24°	38°																																													
光通量	345.3 lm	403.8 lm	258.5 lm																																													
照度距离关系	<table border="1"> <thead> <tr> <th>h(m)</th> <th>E0°(lx)</th> <th>ø(m)</th> </tr> </thead> <tbody> <tr><td>1.50</td><td>1018.54</td><td>0.56</td></tr> <tr><td>2.25</td><td>452.69</td><td>0.84</td></tr> <tr><td>3.50</td><td>187.08</td><td>1.30</td></tr> <tr><td>4.00</td><td>143.23</td><td>1.48</td></tr> </tbody> </table>	h(m)	E0°(lx)	ø(m)	1.50	1018.54	0.56	2.25	452.69	0.84	3.50	187.08	1.30	4.00	143.23	1.48	<table border="1"> <thead> <tr> <th>h(m)</th> <th>E0°(lx)</th> <th>ø(m)</th> </tr> </thead> <tbody> <tr><td>1.50</td><td>535.86</td><td>0.64</td></tr> <tr><td>2.25</td><td>238.16</td><td>0.96</td></tr> <tr><td>3.50</td><td>98.42</td><td>1.49</td></tr> <tr><td>4.00</td><td>75.36</td><td>1.71</td></tr> </tbody> </table>	h(m)	E0°(lx)	ø(m)	1.50	535.86	0.64	2.25	238.16	0.96	3.50	98.42	1.49	4.00	75.36	1.71	<table border="1"> <thead> <tr> <th>h(m)</th> <th>E0°(lx)</th> <th>ø(m)</th> </tr> </thead> <tbody> <tr><td>1.50</td><td>196.43</td><td>1.16</td></tr> <tr><td>2.25</td><td>87.30</td><td>1.75</td></tr> <tr><td>3.50</td><td>36.08</td><td>2.72</td></tr> <tr><td>4.00</td><td>27.62</td><td>3.11</td></tr> </tbody> </table>	h(m)	E0°(lx)	ø(m)	1.50	196.43	1.16	2.25	87.30	1.75	3.50	36.08	2.72	4.00	27.62	3.11
h(m)	E0°(lx)	ø(m)																																														
1.50	1018.54	0.56																																														
2.25	452.69	0.84																																														
3.50	187.08	1.30																																														
4.00	143.23	1.48																																														
h(m)	E0°(lx)	ø(m)																																														
1.50	535.86	0.64																																														
2.25	238.16	0.96																																														
3.50	98.42	1.49																																														
4.00	75.36	1.71																																														
h(m)	E0°(lx)	ø(m)																																														
1.50	196.43	1.16																																														
2.25	87.30	1.75																																														
3.50	36.08	2.72																																														
4.00	27.62	3.11																																														

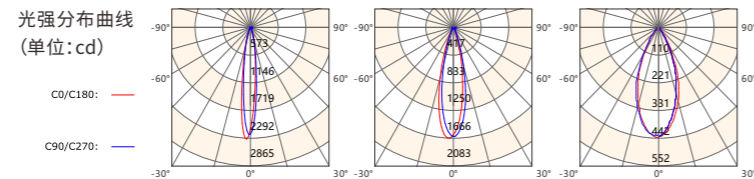

- 可调光
- 安装方便
- CRI 高显指
- 无频闪
- 高效节能
- 名师设计
- 环保材料

适用轨道 (博雅I全系列轨道)

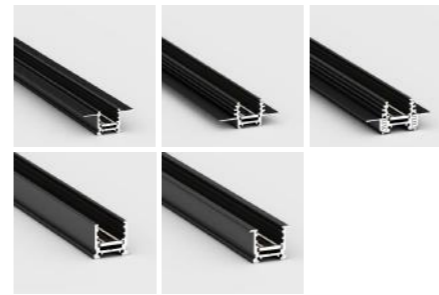

轨道截面图 (mm)

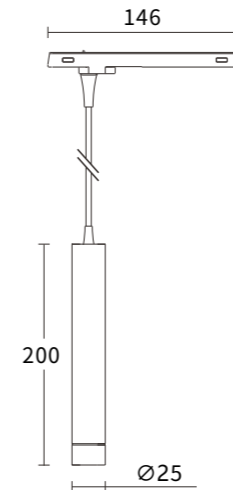

光学参数

光束角	15°	24°	38°																																													
光通量	345.3 lm	403.8 lm	258.5 lm																																													
照度距离关系	<table border="1"> <thead> <tr> <th>h(m)</th> <th>E0°(lx)</th> <th>ø(m)</th> </tr> </thead> <tbody> <tr><td>1.50</td><td>1018.54</td><td>0.56</td></tr> <tr><td>2.25</td><td>452.69</td><td>0.84</td></tr> <tr><td>3.50</td><td>187.08</td><td>1.30</td></tr> <tr><td>4.00</td><td>143.23</td><td>1.48</td></tr> </tbody> </table>	h(m)	E0°(lx)	ø(m)	1.50	1018.54	0.56	2.25	452.69	0.84	3.50	187.08	1.30	4.00	143.23	1.48	<table border="1"> <thead> <tr> <th>h(m)</th> <th>E0°(lx)</th> <th>ø(m)</th> </tr> </thead> <tbody> <tr><td>1.50</td><td>535.86</td><td>0.64</td></tr> <tr><td>2.25</td><td>238.16</td><td>0.96</td></tr> <tr><td>3.50</td><td>98.42</td><td>1.49</td></tr> <tr><td>4.00</td><td>75.36</td><td>1.71</td></tr> </tbody> </table>	h(m)	E0°(lx)	ø(m)	1.50	535.86	0.64	2.25	238.16	0.96	3.50	98.42	1.49	4.00	75.36	1.71	<table border="1"> <thead> <tr> <th>h(m)</th> <th>E0°(lx)</th> <th>ø(m)</th> </tr> </thead> <tbody> <tr><td>1.50</td><td>196.43</td><td>1.16</td></tr> <tr><td>2.25</td><td>87.30</td><td>1.75</td></tr> <tr><td>3.50</td><td>36.08</td><td>2.72</td></tr> <tr><td>4.00</td><td>27.62</td><td>3.11</td></tr> </tbody> </table>	h(m)	E0°(lx)	ø(m)	1.50	196.43	1.16	2.25	87.30	1.75	3.50	36.08	2.72	4.00	27.62	3.11
h(m)	E0°(lx)	ø(m)																																														
1.50	1018.54	0.56																																														
2.25	452.69	0.84																																														
3.50	187.08	1.30																																														
4.00	143.23	1.48																																														
h(m)	E0°(lx)	ø(m)																																														
1.50	535.86	0.64																																														
2.25	238.16	0.96																																														
3.50	98.42	1.49																																														
4.00	75.36	1.71																																														
h(m)	E0°(lx)	ø(m)																																														
1.50	196.43	1.16																																														
2.25	87.30	1.75																																														
3.50	36.08	2.72																																														
4.00	27.62	3.11																																														

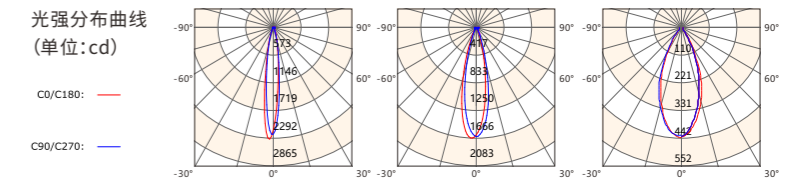

- 可调光
- 安装方便
- CRI 高显指
- 无频闪
- 高效节能
- 名师设计
- 环保材料

吊线灯

产品型号:SG-ZCDX25300/5W
 产品尺寸:∅25*L300mm
 材 质:6063铝
 外观颜色:砂黑色/砂白色
 防护等级:IP20
 调 光:支持
 光 源:Honourtek/Luminus
 电 压:DC24V
 功 率:1W/3W/5W
 色 温:2700K/3000K/4000K
 CRI :≥90
 光 束 角:15°/24°/38°



手感漆表面处理
新工艺 新手感

苹果吊线灯

产品型号:SG-ZCDX6068/5W
 产品尺寸:∅60*L68mm
 材 质:6063铝
 外观颜色:黑色/红色/墨绿色
 防护等级:IP20
 调 光:支持
 光 源:Honourtek/Luminus
 电 压:DC24V
 功 率:5W
 色 温:2700K/3000K/4000K
 CRI :≥90
 光 束 角:15°/24°/38°



适用轨道 (博雅I全系列轨道)

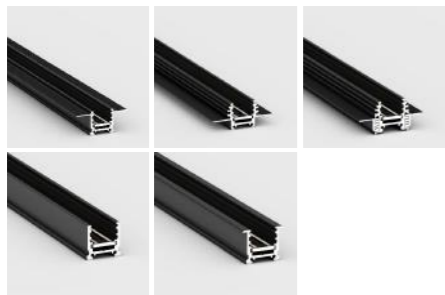

轨道截面图 (mm)

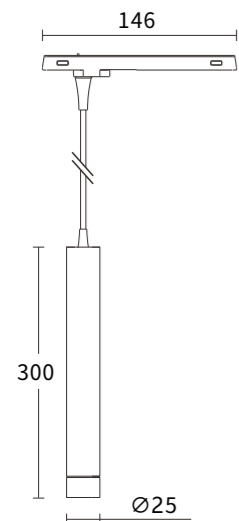

光学参数

光束角	15°	24°	38°																																													
光通量	345.3 lm	403.8 lm	258.5 lm																																													
照度距离关系	<table border="1"> <thead> <tr> <th>h(m)</th> <th>E0°(lx)</th> <th>ø(m)</th> </tr> </thead> <tbody> <tr><td>1.50</td><td>1018.54</td><td>0.56</td></tr> <tr><td>2.25</td><td>452.69</td><td>0.84</td></tr> <tr><td>3.50</td><td>187.08</td><td>1.30</td></tr> <tr><td>4.00</td><td>143.23</td><td>1.48</td></tr> </tbody> </table>	h(m)	E0°(lx)	ø(m)	1.50	1018.54	0.56	2.25	452.69	0.84	3.50	187.08	1.30	4.00	143.23	1.48	<table border="1"> <thead> <tr> <th>h(m)</th> <th>E0°(lx)</th> <th>ø(m)</th> </tr> </thead> <tbody> <tr><td>1.50</td><td>535.86</td><td>0.64</td></tr> <tr><td>2.25</td><td>238.16</td><td>0.96</td></tr> <tr><td>3.50</td><td>98.42</td><td>1.49</td></tr> <tr><td>4.00</td><td>75.36</td><td>1.71</td></tr> </tbody> </table>	h(m)	E0°(lx)	ø(m)	1.50	535.86	0.64	2.25	238.16	0.96	3.50	98.42	1.49	4.00	75.36	1.71	<table border="1"> <thead> <tr> <th>h(m)</th> <th>E0°(lx)</th> <th>ø(m)</th> </tr> </thead> <tbody> <tr><td>1.50</td><td>196.43</td><td>1.16</td></tr> <tr><td>2.25</td><td>87.30</td><td>1.75</td></tr> <tr><td>3.50</td><td>36.08</td><td>2.72</td></tr> <tr><td>4.00</td><td>27.62</td><td>3.11</td></tr> </tbody> </table>	h(m)	E0°(lx)	ø(m)	1.50	196.43	1.16	2.25	87.30	1.75	3.50	36.08	2.72	4.00	27.62	3.11
h(m)	E0°(lx)	ø(m)																																														
1.50	1018.54	0.56																																														
2.25	452.69	0.84																																														
3.50	187.08	1.30																																														
4.00	143.23	1.48																																														
h(m)	E0°(lx)	ø(m)																																														
1.50	535.86	0.64																																														
2.25	238.16	0.96																																														
3.50	98.42	1.49																																														
4.00	75.36	1.71																																														
h(m)	E0°(lx)	ø(m)																																														
1.50	196.43	1.16																																														
2.25	87.30	1.75																																														
3.50	36.08	2.72																																														
4.00	27.62	3.11																																														

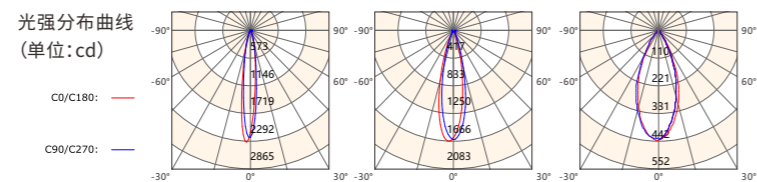

适用轨道 (博雅I全系列轨道)

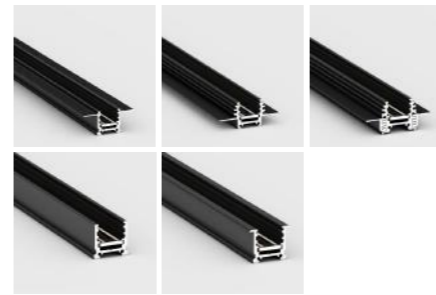

轨道截面图 (mm)

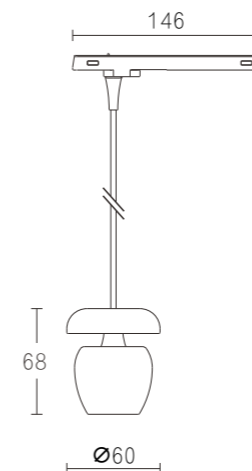

光学参数

光束角	15°	24°	38°																																													
光通量	345.3 lm	403.8 lm	258.5 lm																																													
照度距离关系	<table border="1"> <thead> <tr> <th>h(m)</th> <th>E0°(lx)</th> <th>ø(m)</th> </tr> </thead> <tbody> <tr><td>1.50</td><td>1018.54</td><td>0.56</td></tr> <tr><td>2.25</td><td>452.69</td><td>0.84</td></tr> <tr><td>3.50</td><td>187.08</td><td>1.30</td></tr> <tr><td>4.00</td><td>143.23</td><td>1.48</td></tr> </tbody> </table>	h(m)	E0°(lx)	ø(m)	1.50	1018.54	0.56	2.25	452.69	0.84	3.50	187.08	1.30	4.00	143.23	1.48	<table border="1"> <thead> <tr> <th>h(m)</th> <th>E0°(lx)</th> <th>ø(m)</th> </tr> </thead> <tbody> <tr><td>1.50</td><td>535.86</td><td>0.64</td></tr> <tr><td>2.25</td><td>238.16</td><td>0.96</td></tr> <tr><td>3.50</td><td>98.42</td><td>1.49</td></tr> <tr><td>4.00</td><td>75.36</td><td>1.71</td></tr> </tbody> </table>	h(m)	E0°(lx)	ø(m)	1.50	535.86	0.64	2.25	238.16	0.96	3.50	98.42	1.49	4.00	75.36	1.71	<table border="1"> <thead> <tr> <th>h(m)</th> <th>E0°(lx)</th> <th>ø(m)</th> </tr> </thead> <tbody> <tr><td>1.50</td><td>196.43</td><td>1.16</td></tr> <tr><td>2.25</td><td>87.30</td><td>1.75</td></tr> <tr><td>3.50</td><td>36.08</td><td>2.72</td></tr> <tr><td>4.00</td><td>27.62</td><td>3.11</td></tr> </tbody> </table>	h(m)	E0°(lx)	ø(m)	1.50	196.43	1.16	2.25	87.30	1.75	3.50	36.08	2.72	4.00	27.62	3.11
h(m)	E0°(lx)	ø(m)																																														
1.50	1018.54	0.56																																														
2.25	452.69	0.84																																														
3.50	187.08	1.30																																														
4.00	143.23	1.48																																														
h(m)	E0°(lx)	ø(m)																																														
1.50	535.86	0.64																																														
2.25	238.16	0.96																																														
3.50	98.42	1.49																																														
4.00	75.36	1.71																																														
h(m)	E0°(lx)	ø(m)																																														
1.50	196.43	1.16																																														
2.25	87.30	1.75																																														
3.50	36.08	2.72																																														
4.00	27.62	3.11																																														

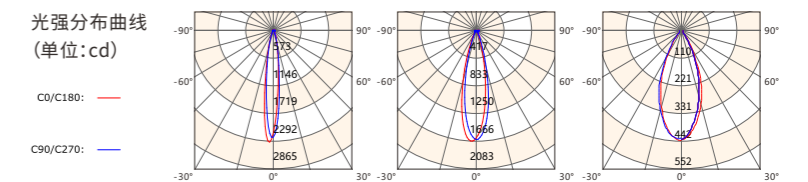

展陈系列灯具通用博雅系列



可调格栅灯

产品型号:SG-ZCGS1552/L211/T5W
 产品尺寸:L211*W15*H52mm
 材 质:6063铝
 外观颜色:砂黑色/砂白色
 防护等级:IP20
 调 光:支持
 光 源:Osram
 电 压:DC24V
 功 率:5W
 色 温:2700K/3000K/4000K
 CRI :≥90
 光 束 角:30°



适用轨道 (博雅I全系列轨道)

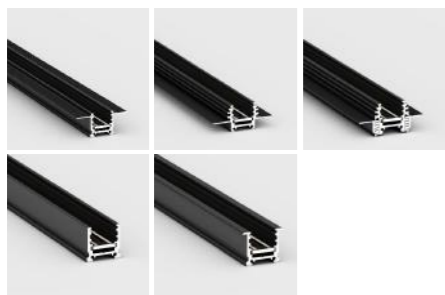

轨道截面图 (mm)

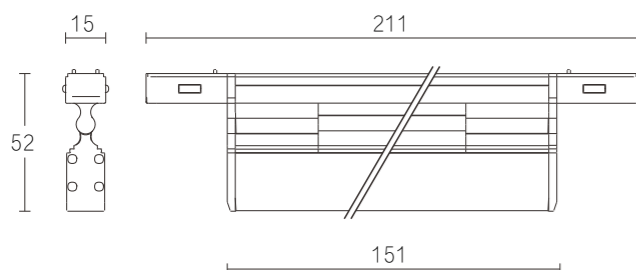

光学参数

光束角	30°																
光通量	102.9 lm																
照度距离关系	<table border="1"> <thead> <tr> <th>h (m)</th> <th>E0° (lx)</th> <th>ø (m)</th> </tr> </thead> <tbody> <tr> <td>1.50</td> <td>142.75</td> <td>1.01</td> </tr> <tr> <td>2.25</td> <td>63.44</td> <td>1.52</td> </tr> <tr> <td>3.50</td> <td>26.22</td> <td>2.37</td> </tr> <tr> <td>4.00</td> <td>20.07</td> <td>2.71</td> </tr> </tbody> </table>		h (m)	E0° (lx)	ø (m)	1.50	142.75	1.01	2.25	63.44	1.52	3.50	26.22	2.37	4.00	20.07	2.71
h (m)	E0° (lx)	ø (m)															
1.50	142.75	1.01															
2.25	63.44	1.52															
3.50	26.22	2.37															
4.00	20.07	2.71															

光强分布曲线 (单位:cd)



可调格栅灯

产品型号:SG-ZCGS1552/L283/T7W
 产品尺寸:L283*W15*H52mm
 材 质:6063铝
 外观颜色:砂黑色/砂白色
 防护等级:IP20
 调 光:支持
 光 源:Osram
 电 压:DC24V
 功 率:7W
 色 温:2700K/3000K/4000K
 CRI :≥90
 光 束 角:30°



适用轨道 (博雅I全系列轨道)

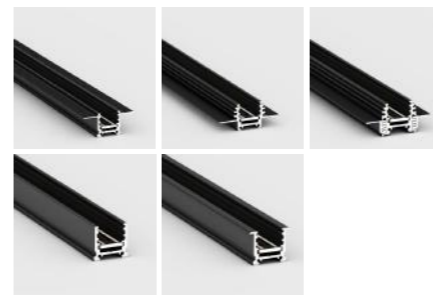

轨道截面图 (mm)

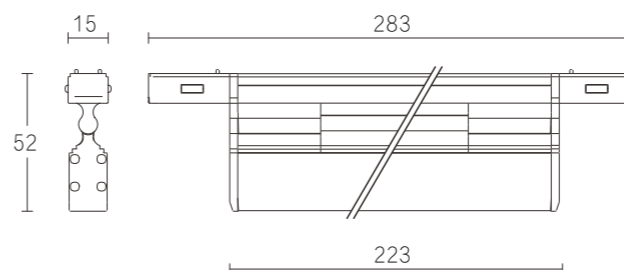

光学参数

光束角	30°																
光通量	149.6 lm																
照度距离关系	<table border="1"> <thead> <tr> <th>h (m)</th> <th>E0° (lx)</th> <th>ø (m)</th> </tr> </thead> <tbody> <tr> <td>1.50</td> <td>207.46</td> <td>1.02</td> </tr> <tr> <td>2.25</td> <td>92.20</td> <td>1.54</td> </tr> <tr> <td>3.50</td> <td>38.10</td> <td>2.39</td> </tr> <tr> <td>4.00</td> <td>29.17</td> <td>2.73</td> </tr> </tbody> </table>		h (m)	E0° (lx)	ø (m)	1.50	207.46	1.02	2.25	92.20	1.54	3.50	38.10	2.39	4.00	29.17	2.73
h (m)	E0° (lx)	ø (m)															
1.50	207.46	1.02															
2.25	92.20	1.54															
3.50	38.10	2.39															
4.00	29.17	2.73															

光强分布曲线 (单位:cd)

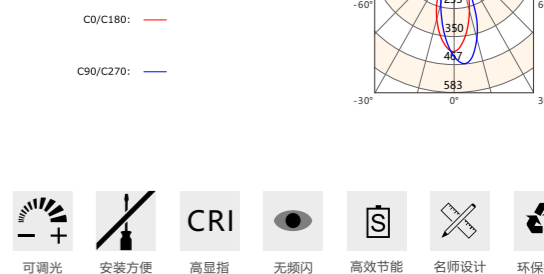

展陈系列灯具通用博雅系列

格栅线性灯

产品型号:SG-ZCGS1511/L72/2W
 产品尺寸:L72*W15*H11mm
 材 质:6063铝
 外观颜色:砂黑色/砂白色
 防护等级:IP20
 调 光:支持
 光 源:Osram
 电 压:DC24V
 功 率:2W
 色 温:2700K/3000K/4000K
 CRI :≥90
 光 束 角:30°



格栅线性灯

产品型号:SG-ZCGS1511/L211/5W
 产品尺寸:L211*W15*H11mm
 材 质:6063铝
 外观颜色:砂黑色/砂白色
 防护等级:IP20
 调 光:支持
 光 源:Osram
 电 压:DC24V
 功 率:5W
 色 温:2700K/3000K/4000K
 CRI :≥90
 光 束 角:30°



适用轨道 (博雅I全系列轨道)

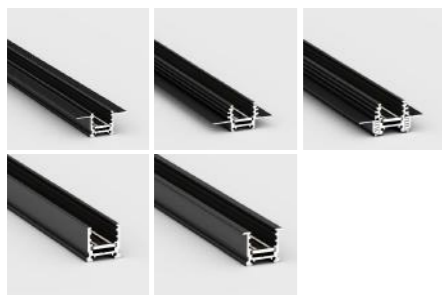

轨道截面图 (mm)

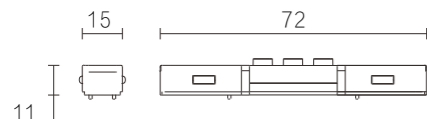

光学参数

光束角	30°																
光通量	48.02 lm																
照度距离关系	<table border="1"> <thead> <tr> <th>h (m)</th> <th>E0° (lx)</th> <th>ø (m)</th> </tr> </thead> <tbody> <tr> <td>1.50</td> <td>70.04</td> <td>1.00</td> </tr> <tr> <td>2.25</td> <td>31.13</td> <td>1.50</td> </tr> <tr> <td>3.50</td> <td>12.86</td> <td>2.34</td> </tr> <tr> <td>4.00</td> <td>9.85</td> <td>2.67</td> </tr> </tbody> </table>		h (m)	E0° (lx)	ø (m)	1.50	70.04	1.00	2.25	31.13	1.50	3.50	12.86	2.34	4.00	9.85	2.67
h (m)	E0° (lx)	ø (m)															
1.50	70.04	1.00															
2.25	31.13	1.50															
3.50	12.86	2.34															
4.00	9.85	2.67															

光强分布曲线 (单位:cd)

C0/C180: —
 C90/C270: —

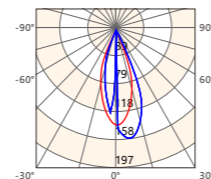

适用轨道 (博雅I全系列轨道)

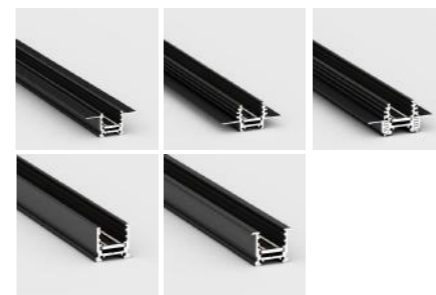

轨道截面图 (mm)

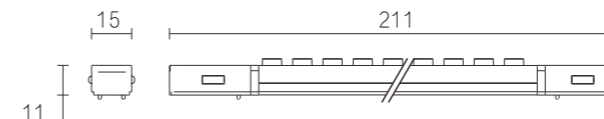

光学参数

光束角	30°																
光通量	102.9 lm																
照度距离关系	<table border="1"> <thead> <tr> <th>h (m)</th> <th>E0° (lx)</th> <th>ø (m)</th> </tr> </thead> <tbody> <tr> <td>1.50</td> <td>142.75</td> <td>1.01</td> </tr> <tr> <td>2.25</td> <td>63.44</td> <td>1.52</td> </tr> <tr> <td>3.50</td> <td>26.22</td> <td>2.37</td> </tr> <tr> <td>4.00</td> <td>20.07</td> <td>2.71</td> </tr> </tbody> </table>		h (m)	E0° (lx)	ø (m)	1.50	142.75	1.01	2.25	63.44	1.52	3.50	26.22	2.37	4.00	20.07	2.71
h (m)	E0° (lx)	ø (m)															
1.50	142.75	1.01															
2.25	63.44	1.52															
3.50	26.22	2.37															
4.00	20.07	2.71															

光强分布曲线 (单位:cd)

C0/C180: —
 C90/C270: —

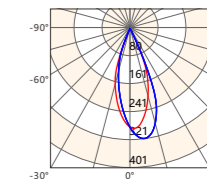

展陈系列灯具通用博雅系列



格栅线性灯

产品型号:SG-ZCGS1511/L355/10W
 产品尺寸:L355*W15*H11mm
 材 质:6063铝
 外观颜色:砂黑色/砂白色
 防护等级:IP20
 调 光:支持
 光 源:Osram
 电 压:DC24V
 功 率:10W
 色 温:2700K/3000K/4000K
 CRI :≥90
 光 束 角:30°



格栅线性灯

产品型号:SG-ZCGS1511/L499/15W
 产品尺寸:L499*W15*H11mm
 材 质:6063铝
 外观颜色:砂黑色/砂白色
 防护等级:IP20
 调 光:支持
 光 源:Osram
 电 压:DC24V
 功 率:15W
 色 温:2700K/3000K/4000K
 CRI :≥90
 光 束 角:30°

适用轨道(博雅I全系列轨道)

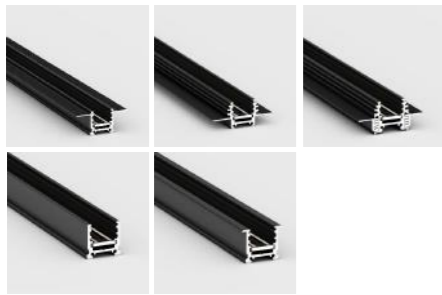

光学参数

光束角	30°																
光通量	194.7 lm																
照度距离关系	<table border="1"> <thead> <tr> <th>h(m)</th> <th>EO°(lx)</th> <th>ø(m)</th> </tr> </thead> <tbody> <tr> <td>1.50</td> <td>261.40</td> <td>1.04</td> </tr> <tr> <td>2.25</td> <td>116.18</td> <td>1.57</td> </tr> <tr> <td>3.50</td> <td>48.01</td> <td>2.44</td> </tr> <tr> <td>4.00</td> <td>36.76</td> <td>2.79</td> </tr> </tbody> </table>		h(m)	EO°(lx)	ø(m)	1.50	261.40	1.04	2.25	116.18	1.57	3.50	48.01	2.44	4.00	36.76	2.79
h(m)	EO°(lx)	ø(m)															
1.50	261.40	1.04															
2.25	116.18	1.57															
3.50	48.01	2.44															
4.00	36.76	2.79															

轨道截面图(mm)

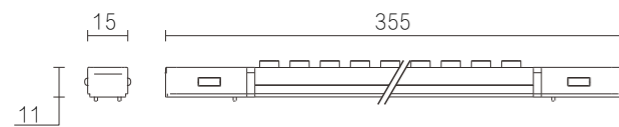

光强分布曲线
(单位:cd)

C0/C180: —
 C90/C270: —

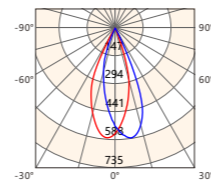

适用轨道(博雅I全系列轨道)

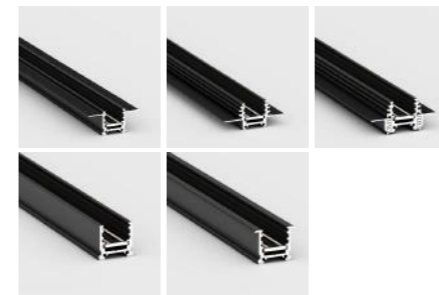

光学参数

光束角	30°																
光通量	498.1 lm																
照度距离关系	<table border="1"> <thead> <tr> <th>h(m)</th> <th>EO°(lx)</th> <th>ø(m)</th> </tr> </thead> <tbody> <tr> <td>1.50</td> <td>358.12</td> <td>0.97</td> </tr> <tr> <td>2.25</td> <td>252.50</td> <td>1.45</td> </tr> <tr> <td>3.50</td> <td>171.29</td> <td>2.26</td> </tr> <tr> <td>4.00</td> <td>74.58</td> <td>2.58</td> </tr> </tbody> </table>		h(m)	EO°(lx)	ø(m)	1.50	358.12	0.97	2.25	252.50	1.45	3.50	171.29	2.26	4.00	74.58	2.58
h(m)	EO°(lx)	ø(m)															
1.50	358.12	0.97															
2.25	252.50	1.45															
3.50	171.29	2.26															
4.00	74.58	2.58															

轨道截面图(mm)

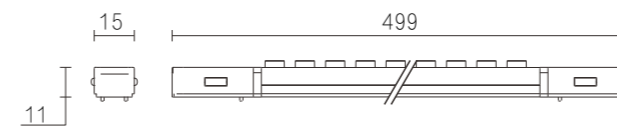

光强分布曲线
(单位:cd)

C0/C180: —
 C90/C270: —

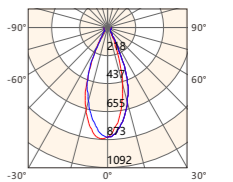

展陈系列灯具通用博雅系列



格栅线性灯

产品型号:SG-ZCGS1511/L715/20W
 产品尺寸:L715*W15*H11mm
 材 质:6063铝
 外观颜色:砂黑色/砂白色
 防护等级:IP20
 调 光:支持
 光 源:Osram
 电 压:DC24V
 功 率:20W
 色 温:2700K/3000K/4000K
 CRI :≥90
 光 束 角:30°



格栅线性灯

产品型号:SG-ZCGS1511/L1003/30W
 产品尺寸:L1003*W15*H11mm
 材 质:6063铝
 外观颜色:砂黑色/砂白色
 防护等级:IP20
 调 光:支持
 光 源:Osram
 电 压:DC24V
 功 率:30W
 色 温:2700K/3000K/4000K
 CRI :≥90
 光 束 角:30°

适用轨道 (博雅I全系列轨道)

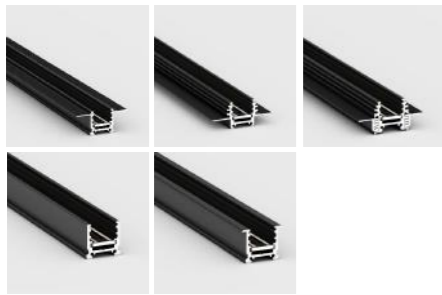

光学参数

光束角	30°																
光通量	656.1 lm																
照度距离关系	<table border="1"> <thead> <tr> <th>h(m)</th> <th>E0°(lx)</th> <th>ø(m)</th> </tr> </thead> <tbody> <tr> <td>1.50</td> <td>598.12</td> <td>3.28</td> </tr> <tr> <td>2.25</td> <td>369.50</td> <td>4.92</td> </tr> <tr> <td>3.50</td> <td>159.29</td> <td>7.65</td> </tr> <tr> <td>4.00</td> <td>94.58</td> <td>8.74</td> </tr> </tbody> </table>		h(m)	E0°(lx)	ø(m)	1.50	598.12	3.28	2.25	369.50	4.92	3.50	159.29	7.65	4.00	94.58	8.74
h(m)	E0°(lx)	ø(m)															
1.50	598.12	3.28															
2.25	369.50	4.92															
3.50	159.29	7.65															
4.00	94.58	8.74															

轨道截面图 (mm)

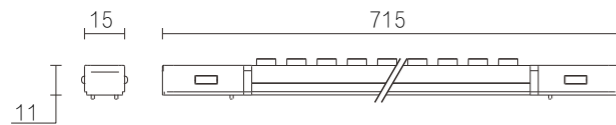

光强分布曲线 (单位:cd)

C0/C180: —
 C90/C270: —

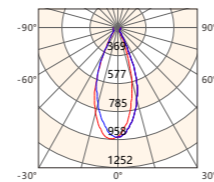

适用轨道 (博雅I全系列轨道)

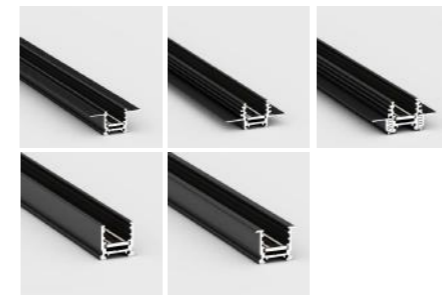

光学参数

光束角	30°																
光通量	921.6 lm																
照度距离关系	<table border="1"> <thead> <tr> <th>h(m)</th> <th>E0°(lx)</th> <th>ø(m)</th> </tr> </thead> <tbody> <tr> <td>1.50</td> <td>893.3</td> <td>3.28</td> </tr> <tr> <td>2.25</td> <td>706.89</td> <td>4.92</td> </tr> <tr> <td>3.50</td> <td>599.36</td> <td>7.65</td> </tr> <tr> <td>4.00</td> <td>456.95</td> <td>8.74</td> </tr> </tbody> </table>		h(m)	E0°(lx)	ø(m)	1.50	893.3	3.28	2.25	706.89	4.92	3.50	599.36	7.65	4.00	456.95	8.74
h(m)	E0°(lx)	ø(m)															
1.50	893.3	3.28															
2.25	706.89	4.92															
3.50	599.36	7.65															
4.00	456.95	8.74															

轨道截面图 (mm)

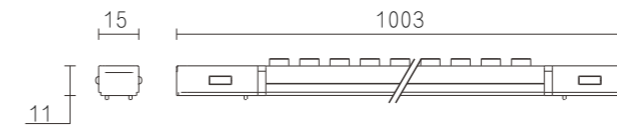

光强分布曲线 (单位:cd)

C0/C180: —
 C90/C270: —

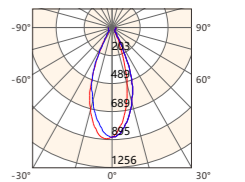

展陈系列灯具通用博雅系列



可调平面线性灯

产品型号:SG-ZCPM1552/L211/T5W
 产品尺寸:L211*W15*H52mm
 材 质:6063铝
 外观颜色:砂黑色/砂白色
 防护等级:IP20
 调 光:支持
 光 源:Osram
 电 压:DC24V
 功 率:5W
 色 温:2700K/3000K/4000K
 CRI :≥90
 光 束 角:100°



适用轨道 (博雅I全系列轨道)

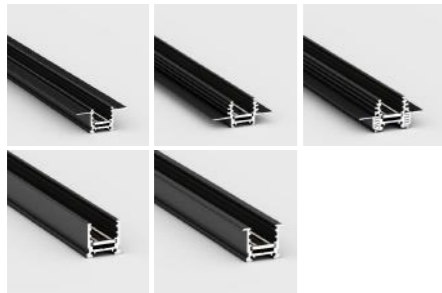

轨道截面图 (mm)

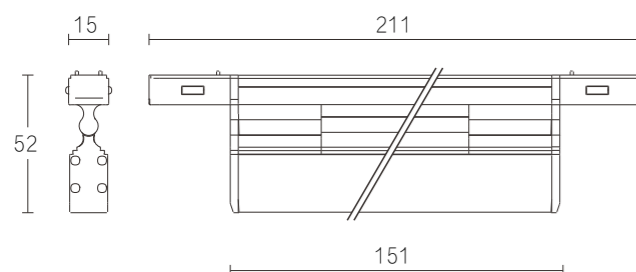

光学参数

光束角 100°

光通量 92 lm

照度距离关系

h (m)	E0° (lx)	ø (m)
1.50	19.93	2.67
2.25	8.86	4.01
3.50	3.66	6.24
4.00	2.80	7.13

光强分布曲线 (单位:cd)

C0/C180: —
 C90/C270: —

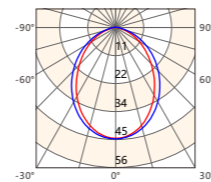

可调平面线性灯

产品型号:SG-ZCPM1552/L283/T7W
 产品尺寸:L283*W15*H52mm
 材 质:6063铝
 外观颜色:砂黑色/砂白色
 防护等级:IP20
 调 光:支持
 光 源:Osram
 电 压:DC24V
 功 率:7W
 色 温:2700K/3000K/4000K
 CRI :≥90
 光 束 角:100°



适用轨道 (博雅I全系列轨道)

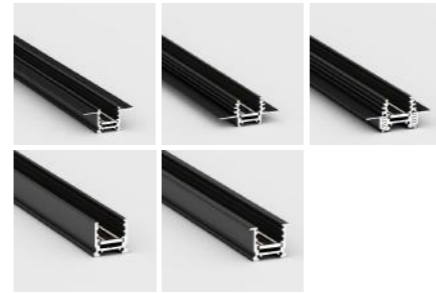

轨道截面图 (mm)

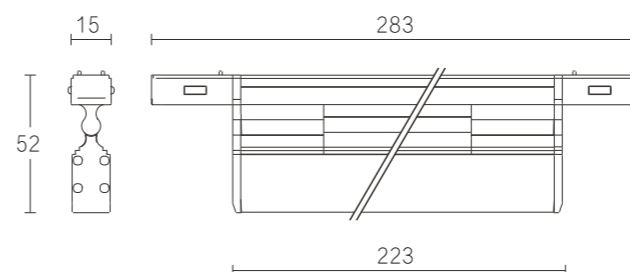

光学参数

光束角 100°

光通量 165.6 lm

照度距离关系

h (m)	E0° (lx)	ø (m)
1.50	32.95	2.86
2.25	14.65	4.29
3.50	6.05	6.67
4.00	4.63	7.62

光强分布曲线 (单位:cd)

C0/C180: —
 C90/C270: —

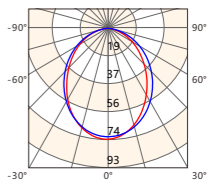

展陈系列灯具通用博雅系列



平面线性灯

产品型号:SG-ZCPM1511/L268/2W
 产品尺寸:L268*W15*H11mm
 材 质:6063铝
 外观颜色:砂黑色/砂白色
 防护等级:IP20
 调 光:支持
 光 源:Osram
 电 压:DC24V
 功 率:2W
 色 温:2700K/3000K/4000K
 CRI :≥90
 光 束 角:100°



平面线性灯

产品型号:SG-ZCPM1511/L468/4W
 产品尺寸:L468*W15*H11mm
 材 质:6063铝
 外观颜色:砂黑色/砂白色
 防护等级:IP20
 调 光:支持
 光 源:Osram
 电 压:DC24V
 功 率:4W
 色 温:2700K/3000K/4000K
 CRI :≥90
 光 束 角:100°

适用轨道 (博雅I全系列轨道)

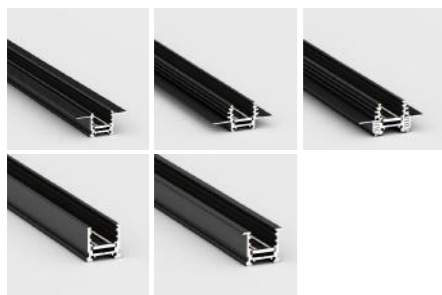

光学参数

光束角	100°																
光通量	28.6 lm																
照度距离关系	<table border="1"> <thead> <tr> <th>h(m)</th> <th>E0°(lx)</th> <th>ø(m)</th> </tr> </thead> <tbody> <tr> <td>1.50</td> <td>7.04</td> <td>2.65</td> </tr> <tr> <td>2.25</td> <td>3.13</td> <td>3.98</td> </tr> <tr> <td>3.50</td> <td>1.29</td> <td>6.18</td> </tr> <tr> <td>4.00</td> <td>0.99</td> <td>7.07</td> </tr> </tbody> </table>		h(m)	E0°(lx)	ø(m)	1.50	7.04	2.65	2.25	3.13	3.98	3.50	1.29	6.18	4.00	0.99	7.07
h(m)	E0°(lx)	ø(m)															
1.50	7.04	2.65															
2.25	3.13	3.98															
3.50	1.29	6.18															
4.00	0.99	7.07															

轨道截面图 (mm)

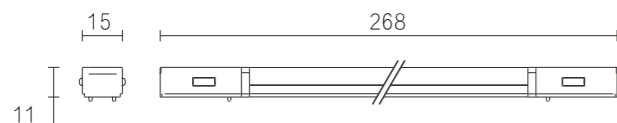

光强分布曲线 (单位:cd)

C0/C180: —
 C90/C270: —

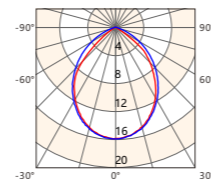

适用轨道 (博雅I全系列轨道)

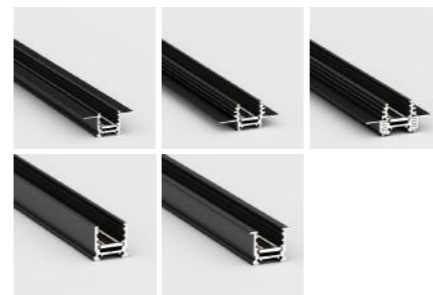

光学参数

光束角	100°																
光通量	71.44 lm																
照度距离关系	<table border="1"> <thead> <tr> <th>h(m)</th> <th>E0°(lx)</th> <th>ø(m)</th> </tr> </thead> <tbody> <tr> <td>1.50</td> <td>15.38</td> <td>2.93</td> </tr> <tr> <td>2.25</td> <td>6.84</td> <td>4.40</td> </tr> <tr> <td>3.50</td> <td>2.83</td> <td>6.84</td> </tr> <tr> <td>4.00</td> <td>2.16</td> <td>7.82</td> </tr> </tbody> </table>		h(m)	E0°(lx)	ø(m)	1.50	15.38	2.93	2.25	6.84	4.40	3.50	2.83	6.84	4.00	2.16	7.82
h(m)	E0°(lx)	ø(m)															
1.50	15.38	2.93															
2.25	6.84	4.40															
3.50	2.83	6.84															
4.00	2.16	7.82															

轨道截面图 (mm)

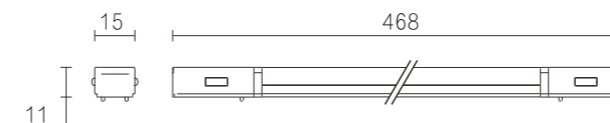

光强分布曲线 (单位:cd)

C0/C180: —
 C90/C270: —

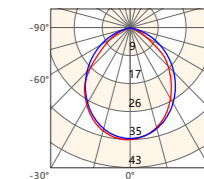

展陈系列灯具通用博雅系列



平面线性灯

产品型号:SG-ZCPM1511/L668/6W
 产品尺寸:L668*W15*H11mm
 材 质:6063铝
 外观颜色:砂黑色/砂白色
 防护等级:IP20
 调 光:支持
 光 源:Osram
 电 压:DC24V
 功 率:6W
 色 温:2700K/3000K/4000K
 CRI :≥90
 光 束 角:100°

适用轨道 (博雅I全系列轨道)

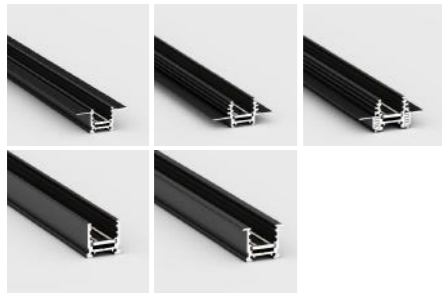

轨道截面图 (mm)

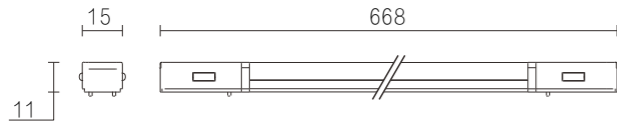

光学参数

光束角	100°																
光通量	122.88 lm																
照度距离关系	<table border="1"> <thead> <tr> <th>h(m)</th> <th>E0°(lx)</th> <th>ø(m)</th> </tr> </thead> <tbody> <tr> <td>1.50</td> <td>31.76</td> <td>2.89</td> </tr> <tr> <td>2.25</td> <td>14.68</td> <td>4.45</td> </tr> <tr> <td>3.50</td> <td>6.66</td> <td>7.04</td> </tr> <tr> <td>4.00</td> <td>4.32</td> <td>8.12</td> </tr> </tbody> </table>		h(m)	E0°(lx)	ø(m)	1.50	31.76	2.89	2.25	14.68	4.45	3.50	6.66	7.04	4.00	4.32	8.12
h(m)	E0°(lx)	ø(m)															
1.50	31.76	2.89															
2.25	14.68	4.45															
3.50	6.66	7.04															
4.00	4.32	8.12															

光强分布曲线 (单位:cd)

C0/C180: —
C90/C270: —

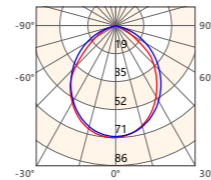

平面线性灯

产品型号:SG-ZCPM1511/L868/8W
 产品尺寸:L868*W15*H11mm
 材 质:6063铝
 外观颜色:砂黑色/砂白色
 防护等级:IP20
 调 光:支持
 光 源:Osram
 电 压:DC24V
 功 率:8W
 色 温:2700K/3000K/4000K
 CRI :≥90
 光 束 角:100°

适用轨道 (博雅I全系列轨道)

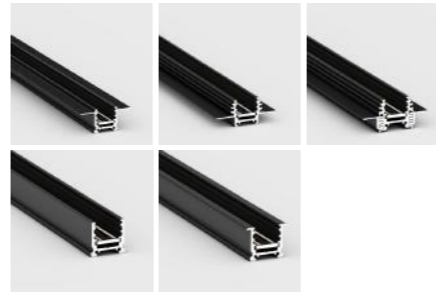

轨道截面图 (mm)

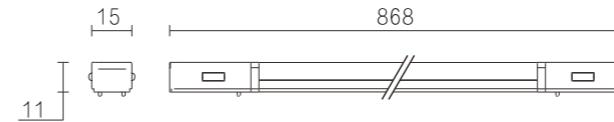

光学参数

光束角	100°																
光通量	245.8 lm																
照度距离关系	<table border="1"> <thead> <tr> <th>h(m)</th> <th>E0°(lx)</th> <th>ø(m)</th> </tr> </thead> <tbody> <tr> <td>1.50</td> <td>40.32</td> <td>3.28</td> </tr> <tr> <td>2.25</td> <td>17.92</td> <td>4.92</td> </tr> <tr> <td>3.50</td> <td>7.40</td> <td>7.65</td> </tr> <tr> <td>4.00</td> <td>5.67</td> <td>8.74</td> </tr> </tbody> </table>		h(m)	E0°(lx)	ø(m)	1.50	40.32	3.28	2.25	17.92	4.92	3.50	7.40	7.65	4.00	5.67	8.74
h(m)	E0°(lx)	ø(m)															
1.50	40.32	3.28															
2.25	17.92	4.92															
3.50	7.40	7.65															
4.00	5.67	8.74															

光强分布曲线 (单位:cd)

C0/C180: —
C90/C270: —

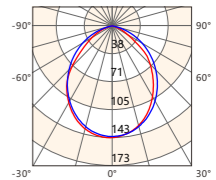

展陈系列灯具通用博雅系列



平面线性灯

产品型号:SG-ZCPM1511/L1068/10W
 产品尺寸:L1068*W15*H11mm
 材 质:6063铝
 外观颜色:砂黑色/砂白色
 防护等级:IP20
 调 光:支持
 光 源:Osram
 电 压:DC24V
 功 率:10W
 色 温:2700K/3000K/4000K
 CRI :≥90
 光 束 角:100°

适用轨道 (博雅I全系列轨道)

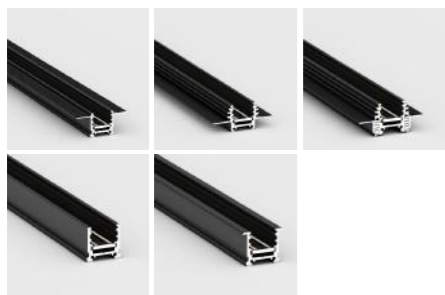

轨道截面图 (mm)

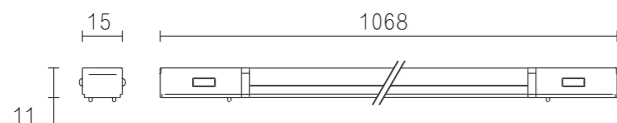

光学参数

光束角 100°

光通量 491.6 lm

照度距离关系

h(m)	E0°(lx)	φ(m)
1.50	80.64	3.85
2.25	36.87	4.96
3.50	15.20	7.77
4.00	11.74	8.87

光强分布曲线
(单位:cd)

C0/C180: —
C90/C270: —

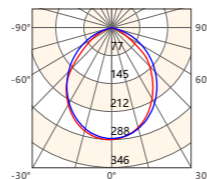

应用案例示例



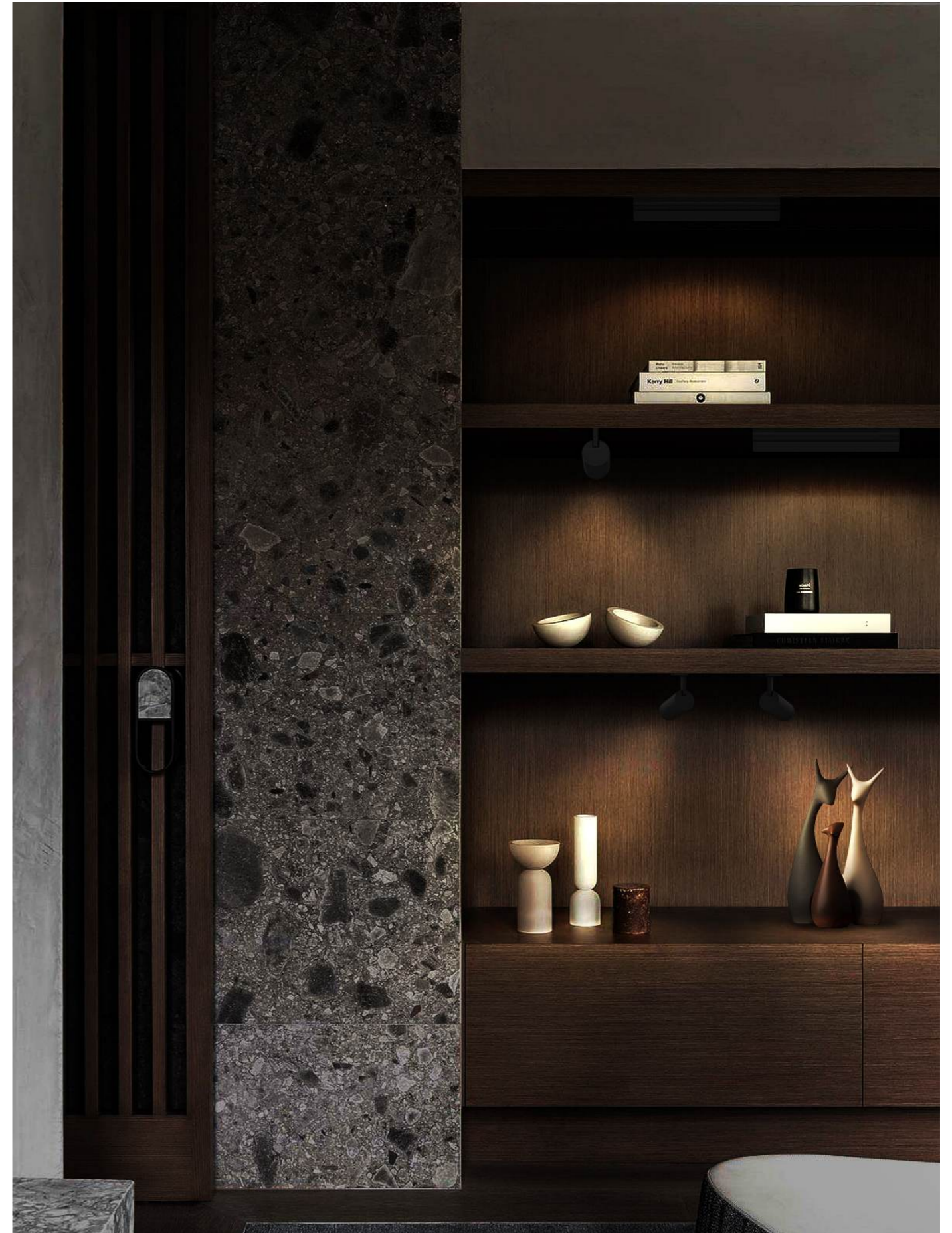





预埋式/嵌入式主体开孔尺寸汇总

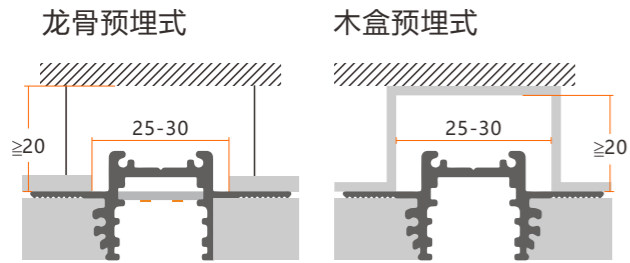

产品名称：博雅I系列无边预埋式轨道
产品型号：SG-GD4820Y/L1000
开孔尺寸：W25*H20mm

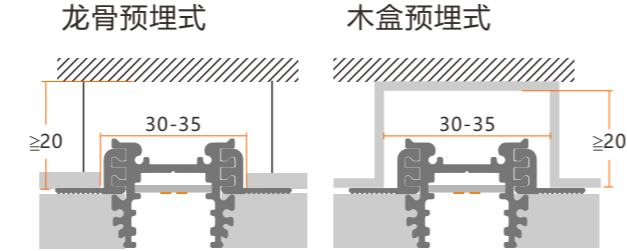

产品名称：博雅I系列可调预埋式轨道
产品型号：SG-GD4822Y/L1000
开孔尺寸：W30*H20mm

表面嵌入式

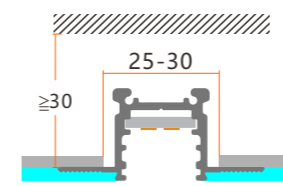

产品名称：博雅I系列无边表面嵌入式轨道
产品型号：SG-GD4520Q/L1000
开孔尺寸：W25*H30mm

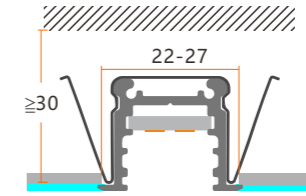

产品名称：博雅I系列有边框表面嵌入式轨道
产品型号：SG-GD2620Q/L1000
开孔尺寸：W22*H30mm

温馨提示/警告:

1. 成套照明系统均采用DC24V开关电源供电，匹配电源时，开关电源总功率需大于发光体功率20%以上，例如某组线路安装线性灯5支，每支功率12W，总功率为60W，那么应配置总功率为75W以上开关电源。
2. 为使压降降到最小，灯具轨道安装长度不适合超过5米，5米为一组单独分线供电，如有必要，建议3米为一组进行单独分线于电源供电。
3. 产品默认出厂控制设置接线方式（如上图），如有特殊要求控制方式，请与生产商联系，沟通，请勿私自更改线路及控制方式。
4. 任何情况下，灯具都不能被隔热衬垫或类似材料覆盖！

产品默认出厂控制设置接线方式

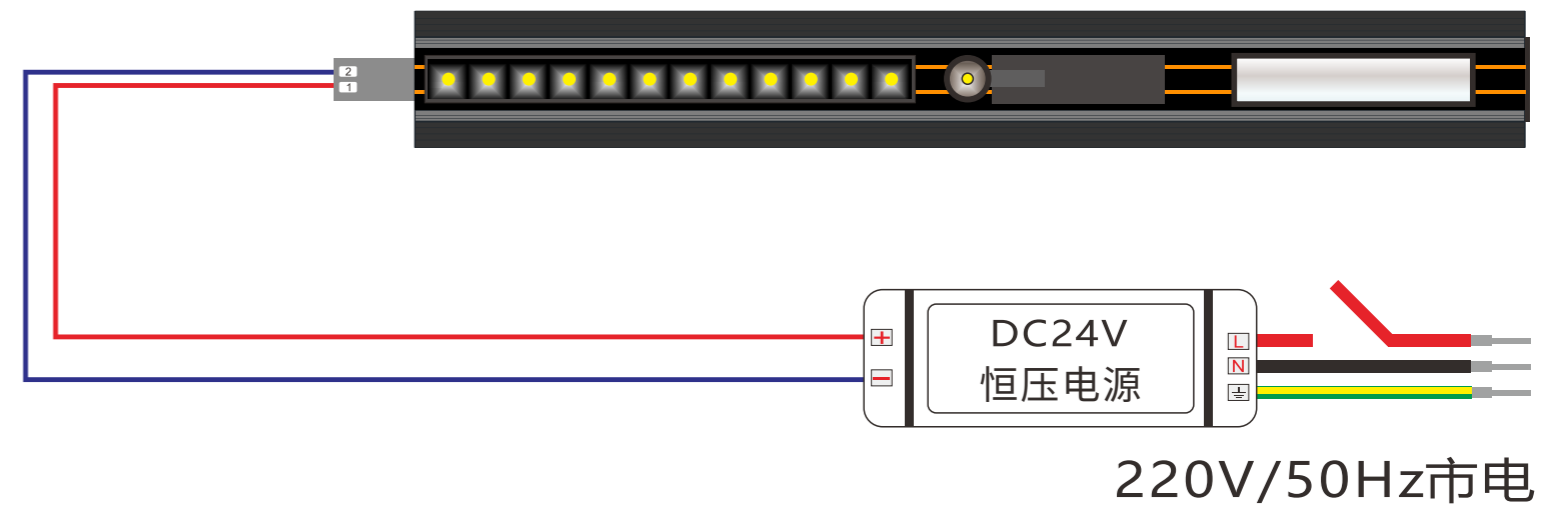

预埋式主体-龙骨结构安装方式

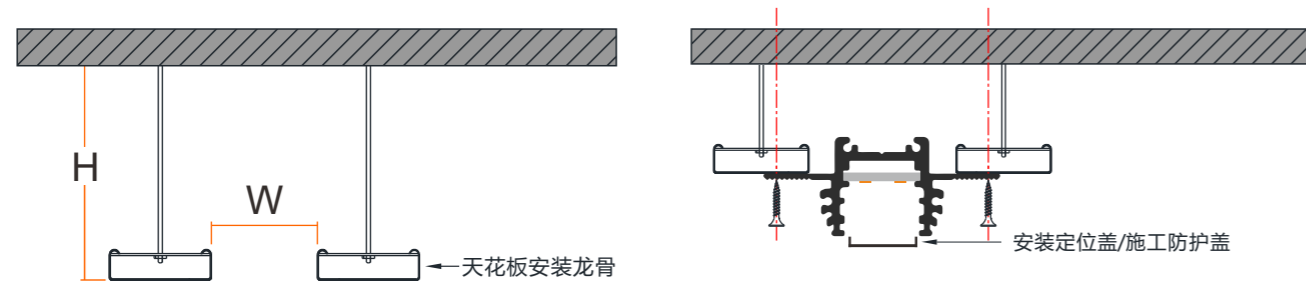

- 1 按照轨道开孔尺寸预留轨道安装空间。
- 2 用“安装定位盖/施工防护盖”盖好轨道；再将轨道嵌入到安装槽内，用自攻螺丝钉把轨道固定好。

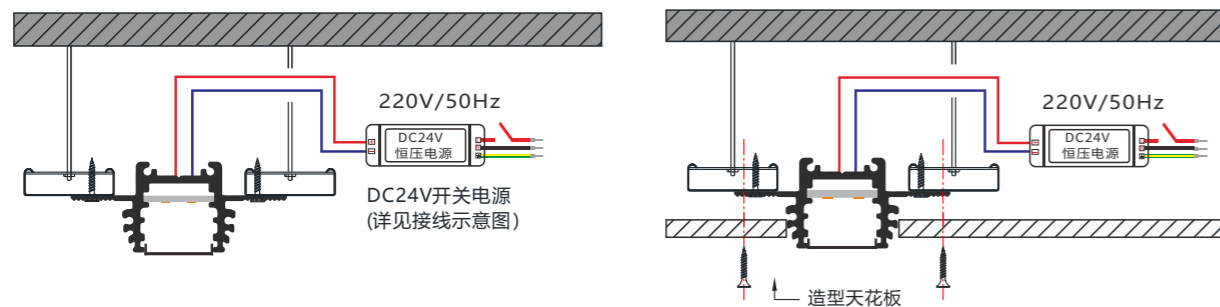

- 3 连接轨道供电系统（详见接线示意图）
- 4 确认完全连接好供电系统，并确保轨道供电全线畅通，然后安装造型天花板。

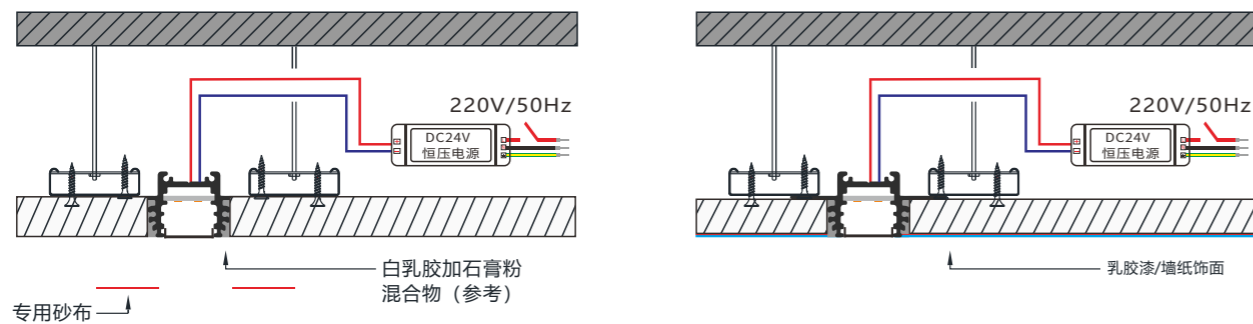

- 5 用白乳胶加石膏粉混合（参考）填补轨道与天花板之间的缝隙，再用专用砂布粘上补好，缝口处补好后待干透。
- 6 做天花饰面,饰面做乳胶漆/墙纸/其他，完成天花饰面后,移除安装定位盖/施工防护盖,安装灯具，合上电闸亮灯。

预埋式主体-木盒结构安装方式

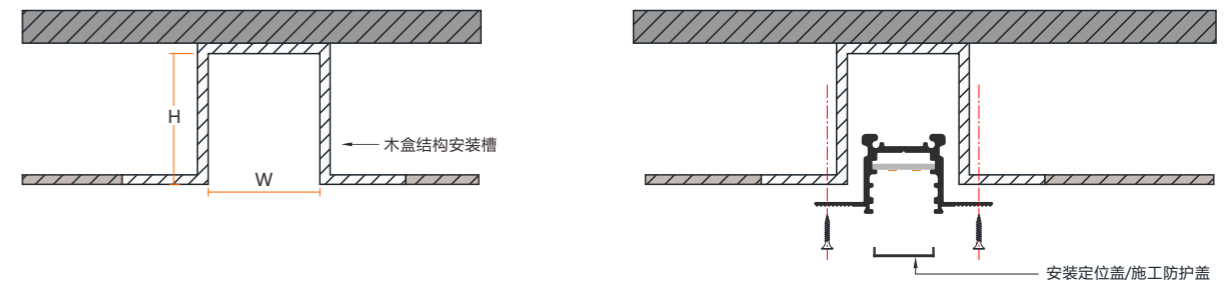

- 1 制作木盒安装槽,按照轨道开孔尺寸预留轨道安装空间
- 2 用“安装定位盖/施工防护盖”盖好轨道,固定制作好的木盒安装槽，再将轨道嵌入到安装槽内，用自攻螺丝钉把轨道固定好。

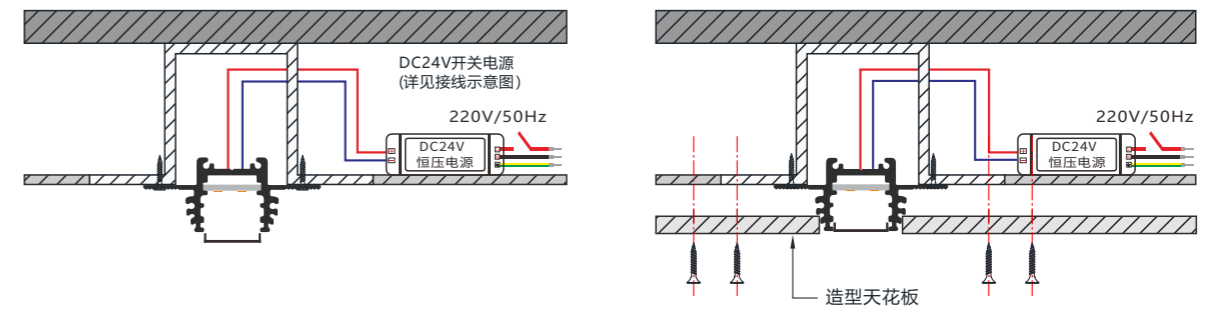

- 3 连接轨道供电系统（详见接线示意图）
- 4 安装天花板前，确认完全连接好供电系统，并确保轨道供电全线畅通，在安装造型天花板。

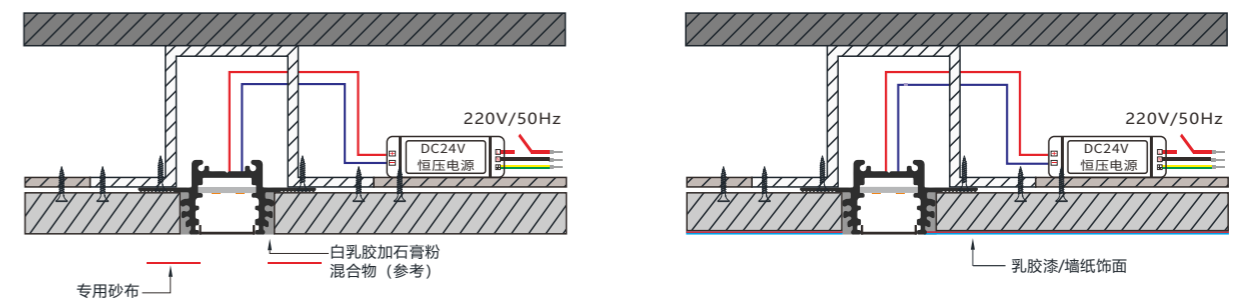

- 5 用白乳胶加石膏粉混合（参考）填补轨道与天花板之间的缝隙，再用专用砂布粘上补好，缝口处补好后待干透。
- 6 做天花饰面,饰面做乳胶漆/墙纸/其他，完成天花饰面后,移除安装定位盖/施工防护盖,安装灯具，合上电闸亮灯。

表面嵌入式主体安装方式

悬挂/吸顶式主体安装方式

- 1 确定轨道安装位置，按照轨道开孔尺寸预留轨道安装空间。

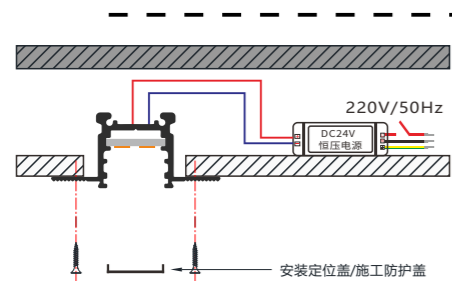
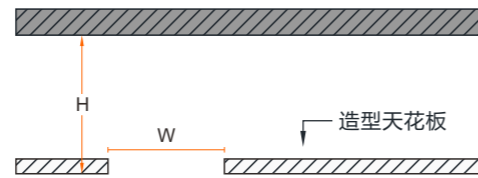

- 2 连接轨道供电系统（详见接线示意图）用自攻螺丝钉把灯具轨道固定在造型天花板的安装槽内。确认完全连接好供电系统，并确保轨道供电全线畅通。

- 3 做天花饰面，饰面做乳胶漆/墙纸/其他，完成天花饰面后，移除安装定位盖/施工防护盖，安装灯具，合上电闸亮灯。

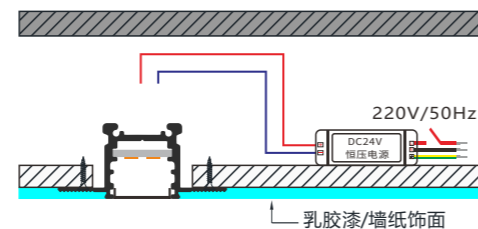

无边框表面嵌入式

吸顶安装方式

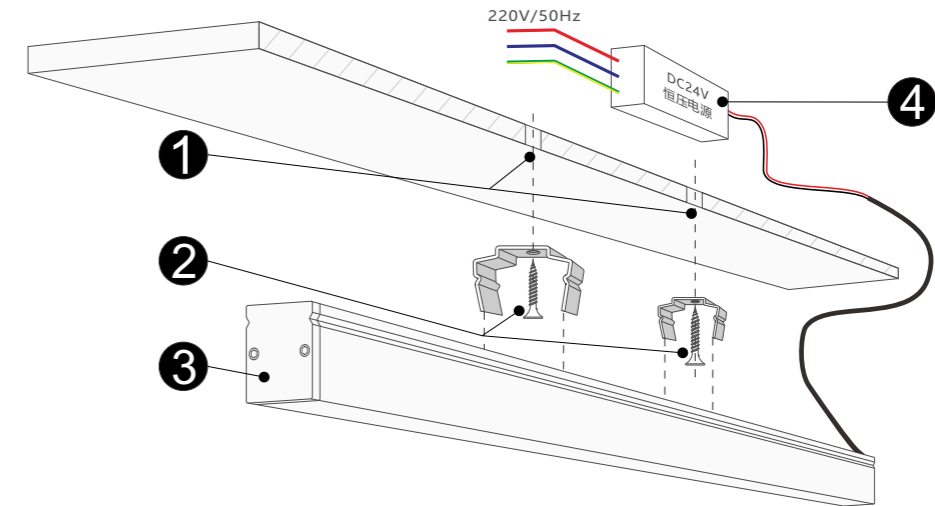

- 1 定好轨道安装位置，按照轨道的孔位尺寸打孔打上膨胀螺钉（如果是木板或者其他吊顶，直接打自攻螺丝）
- 2 用配件包上的螺丝将轨道挂板固定好，轨道对准插入挂板槽
- 3 将轨道堵头装好
- 4 链接DC24V电源（链接方式参考接线示意图），确保电源畅通，装上灯具，打开电闸亮灯。

- 1 确定轨道安装位置，按照轨道开孔尺寸预留轨道安装空间。

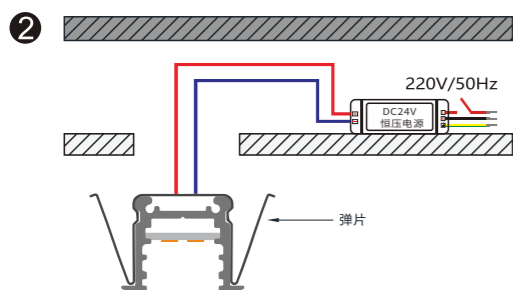
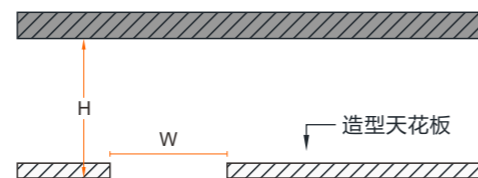

- 2 链接好灯具轨道电源（详见接线示意图）安装轨道前，确认完全连接好供电系统，并确保轨道供电全线畅通。用“安装定位盖/施工防护盖”盖好轨道；将轨道弹片往上拨好，将轨道顺着安装槽嵌入。

- 3 安装固定好轨道后，移除安装定位盖/施工防护盖，安装灯具，合上电闸亮灯。

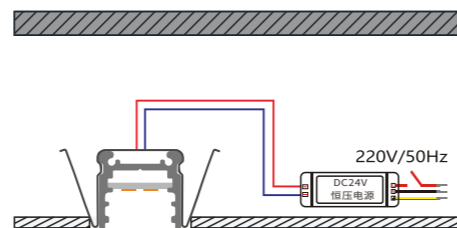

有边框表面嵌入式

悬挂安装方式

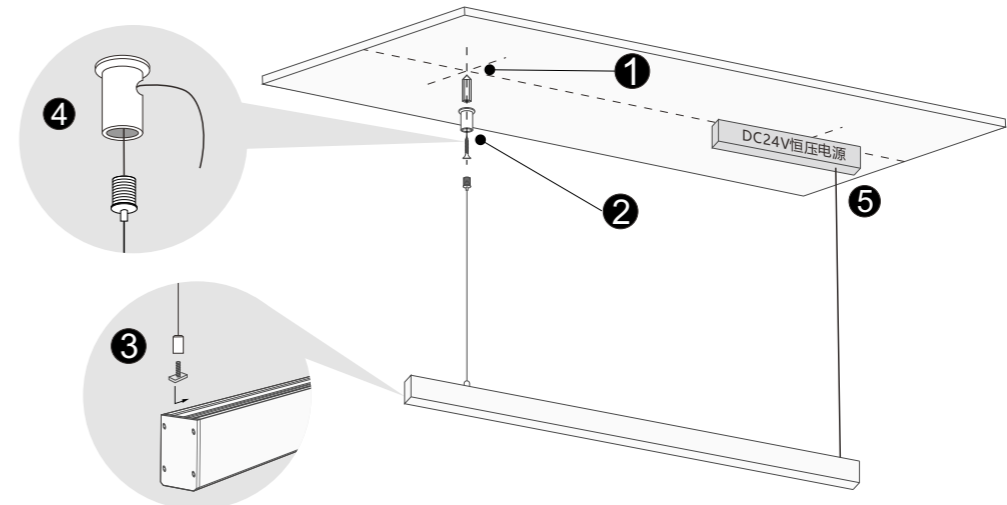

- 1 定好轨道安装位置，按照轨道的孔位打孔，打上膨胀螺丝（如果是木板，直接打自攻螺丝）
- 2 用螺丝钉将灯具悬挂配件固定好
- 3 将轨道端的悬挂配件顺着卡槽卡进轨道，定好位置再把悬挂钢丝上的螺母拧紧
- 4 按照示意图把钢丝先串好，再把堵头拧紧，然后用钢丝调好轨道的悬挂高度
- 5 链接DC24V电源（详见接线示意图），确保电源畅通，装上灯具，打开电闸亮灯。



广东三谷照明科技有限公司

Guangdong Sangu Lighting Technology Co., Ltd

服务热线：0760-88752042

招商热线：13346496970 13425587944

地址：广东省中山市横栏镇茂辉工业区富横西路金盛工业园B栋