

22系列

三谷照明磁吸组合照明系统
专业版

22型专业版磁吸组合轨道 / Type 22 professional track

一体预埋式
SG-GD7075Y/G



表面嵌入式
SG-GD7275B/G



明装
SG-GD3585D/G

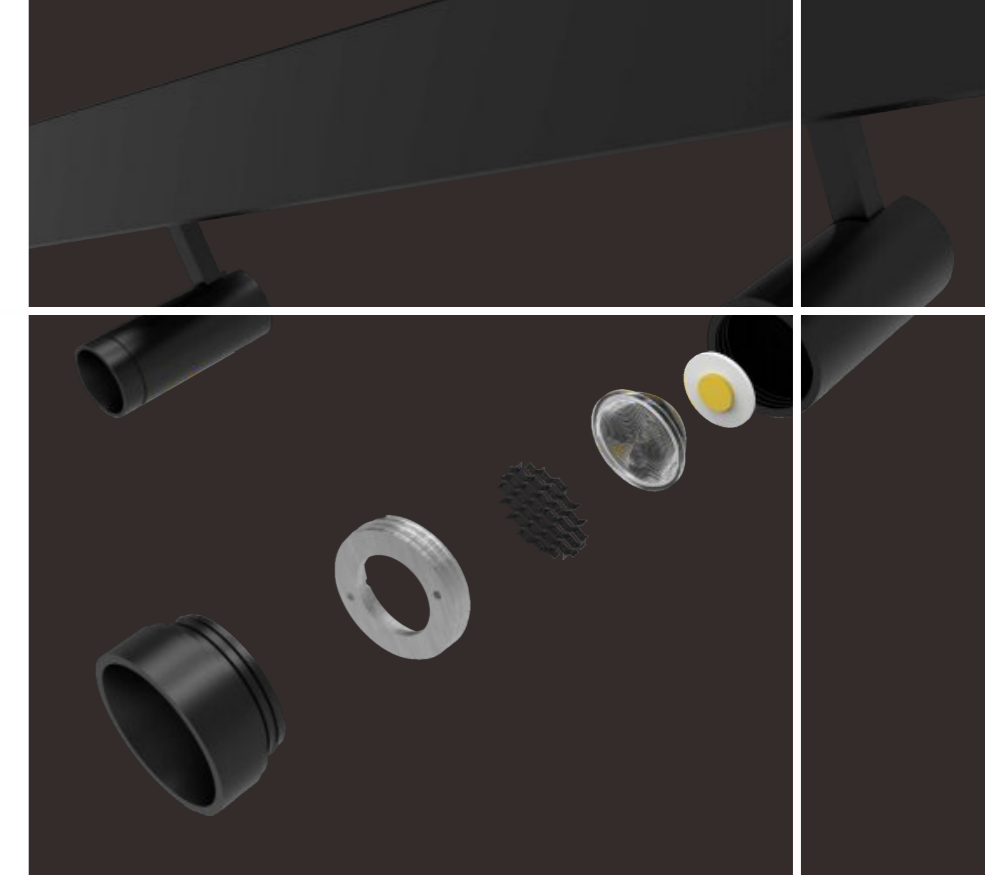
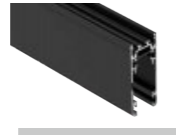

22型专业版磁吸组合照明灯具 / Type 22 professional luminaire



射灯
SG-SD2265/3W



射灯
SG-SD223463/5W



射灯
SG-SD2234100/8W



吊线灯
SG-DXD2225300/5W



吊线灯
SG-DXD2234200/5W/8W/10W



吊线灯
SG-DXD226068/5W



吊线灯
SG-DXD228395/8W



吊线灯
SG-DXD227568/5W/A



吊线灯
SG-DXD227568/5W/B



吊线灯 (大锐曲)
SG-DXD2275100/5W/8W



吊线灯 (麦语)
SG-DXD226080/5W/A



吊线灯 (朵意)
SG-DXD226375/5W/B



吊线灯 (锐曲)
SG-DXD226875/5W/C



吊线灯 (舒意)
SG-DXD226075/5W/D



吊线灯 (灵笈)-小
SG-DXD22100110/3W



吊线灯 (灵笈)-中
SG-DXD22150165/4W



吊线灯 (灵笈)-大
SG-DXD22200225/5W



180°可调格栅线性灯
SG-GSD22155/L220/T12W/G



格栅线性灯
SG-GSD2265/L220/12W/G



格栅线性灯
SG-GSD2265/L545/25W/G



180°可调平面发光线性灯
SG-PMD22155/L220/T8W/G



平面发光线性灯
SG-PMD2265/L247/8W/G



平面发光线性灯
SG-PMD2265/L485/16W/G



平面发光线性灯
SG-PMD2265/L965/30W/G

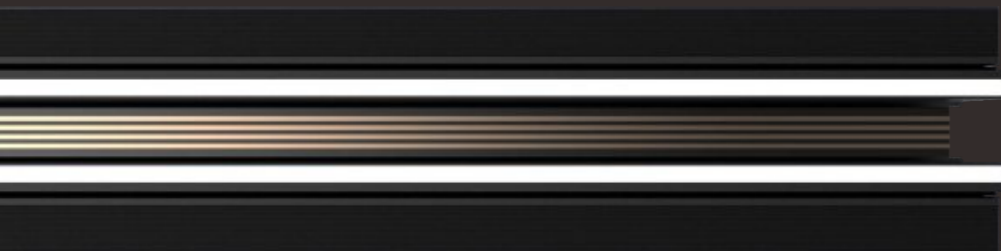

随意触碰
采用DC24V安全电压设计，正常DC24V电压通电可触碰。

22

型系列产品...

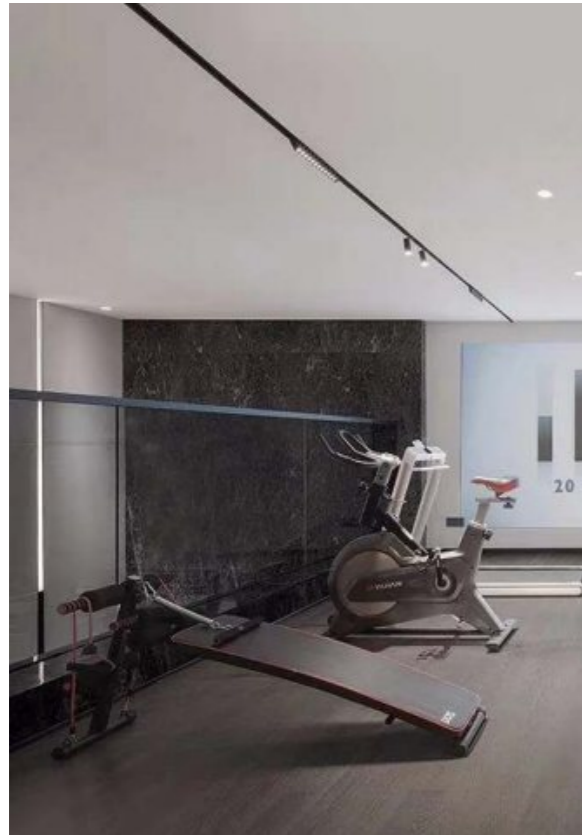

轨道与灯具之间用磁吸加机械卡扣方式锁死，更加牢固

适用配件

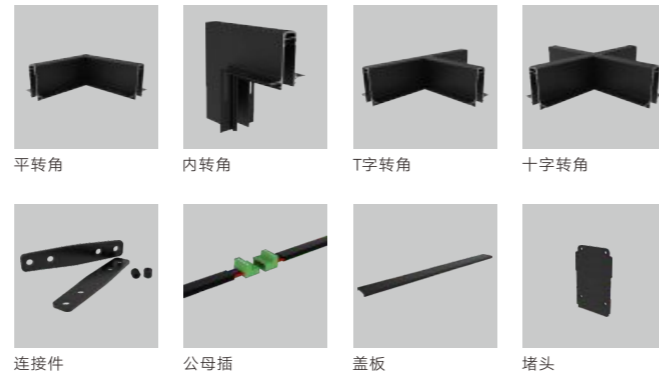

适用灯具



安装方式

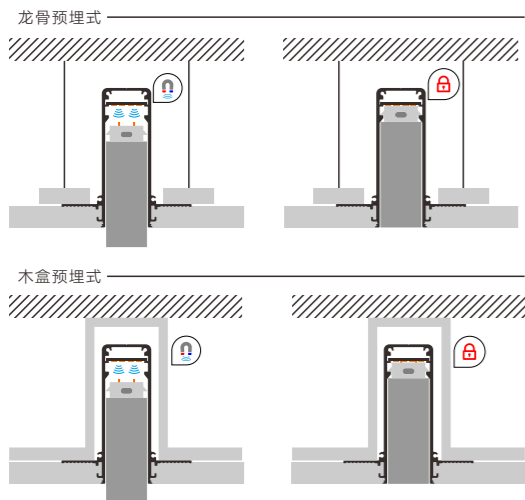

轨道与灯具之间用磁吸加机械卡扣方式锁死，更加牢固

轨道截面尺寸图 (单位: mm)

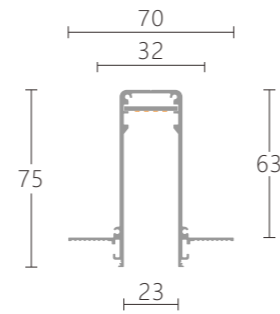

- ◆ 开孔高度计算方式为轨道顶部到固定板高度+10mm供电线空间+15mm接线公母插空间+5mm接线公母插空间
- ◆ 开孔宽度计算方式为要埋入的轨道最大尺寸+5mm活动空间

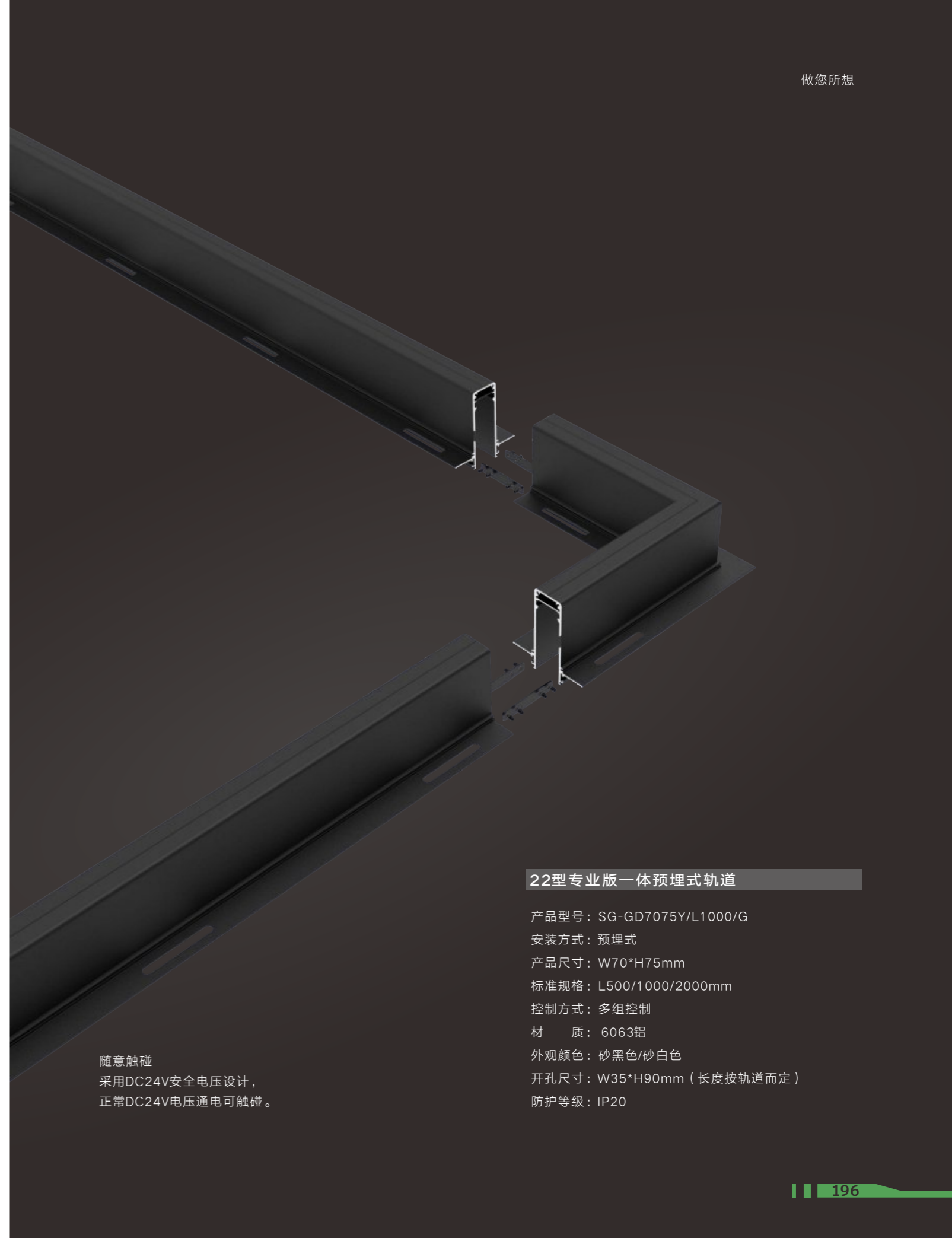

22型专业版一体预埋式轨道

- 产品型号: SG-GD7075Y/L1000/G
- 安装方式: 预埋式
- 产品尺寸: W70*H75mm
- 标准规格: L500/1000/2000mm
- 控制方式: 多组控制
- 材质: 6063铝
- 外观颜色: 砂黑色/砂白色
- 开孔尺寸: W35*H90mm (长度按轨道而定)
- 防护等级: IP20

随意触碰
采用DC24V安全电压设计，
正常DC24V电压通电可触碰。



22型专业版无边框表面嵌入式轨道

产品型号：SG-GD7275B/L1000/G
 安装方式：无边框表面嵌入式
 产品尺寸：W72*H75mm
 标准规格：L500/1000/2000mm
 控制方式：多组控制
 材 质：6063铝
 外观颜色：砂黑色/砂白色
 开孔尺寸：W40*H95mm（长度按轨道而定）
 防护等级：IP20

随意触碰
 采用DC24V安全电压设计，
 正常DC24V电压通电可触碰。



轨道与灯具之间用磁吸加机械卡扣方式锁死，更加牢固

适用配件

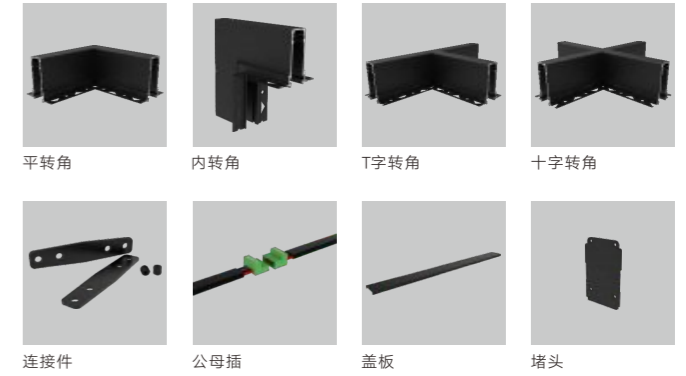

适用灯具



安装方式

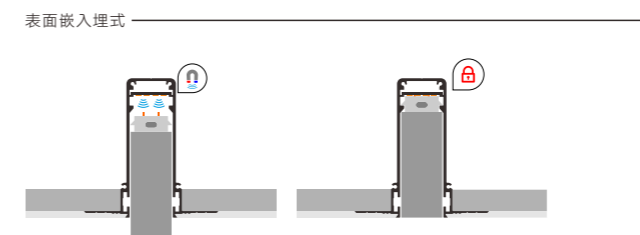

轨道与灯具之间采用磁吸加机械卡扣方式锁死，更加牢固

轨道截面尺寸图 (单位: mm)

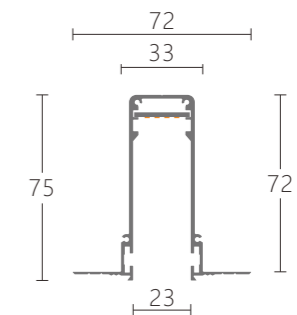

- ◆ 开孔高度计算方式为轨道顶部到固定板高度+10mm供电线空间+15mm接线公母插空间+5mm接线公母插空间
- ◆ 开孔宽度计算方式为要埋入的轨道最大尺寸+5mm活动空间

22型专业版明装轨道

产品型号：SG-GD3585D/L1000/G
 安装方式：悬挂式/吸顶式
 产品尺寸：W35*H85mm
 标准规格：L1000/1500/2000mm
 控制方式：多组控制
 材 质：6063铝
 外观颜色：砂黑色/砂白色
 防护等级：IP20

轨道截面尺寸图 (单位: mm)

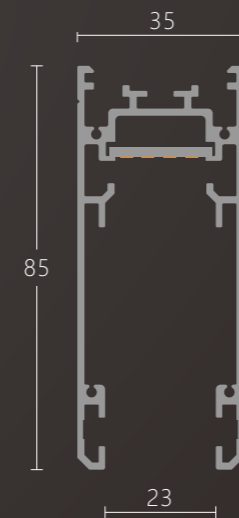

适用灯具

安装方式

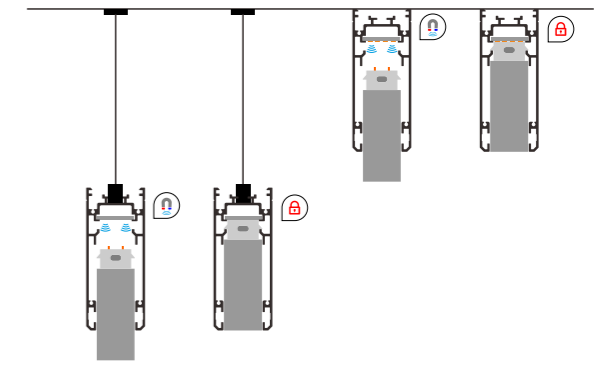

轨道与灯具之间采用磁吸加机械卡扣方式锁死，更加牢固

适用配件



随意触碰
 采用DC24V安全电压设计，正常DC24V电压通电可触碰。

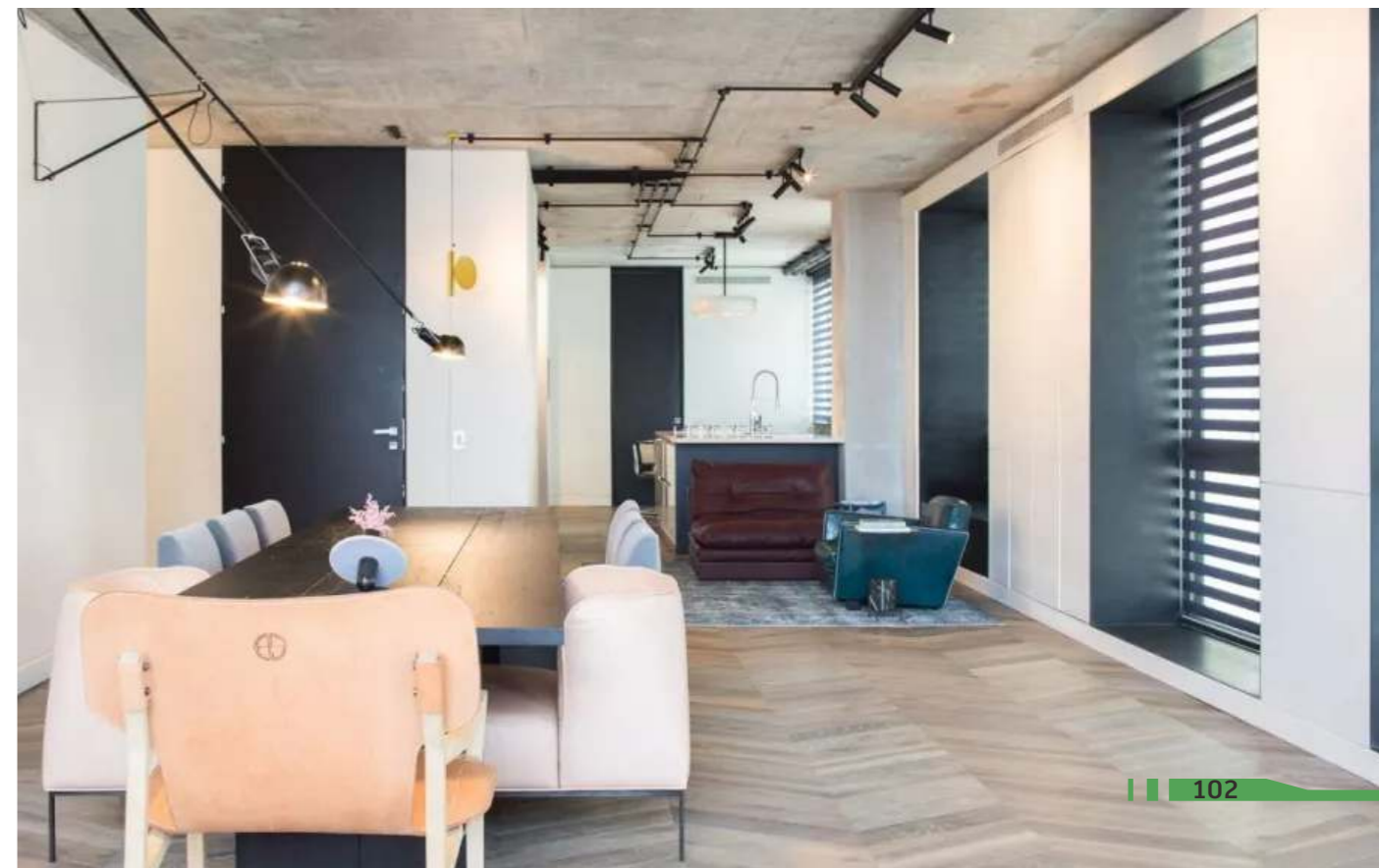

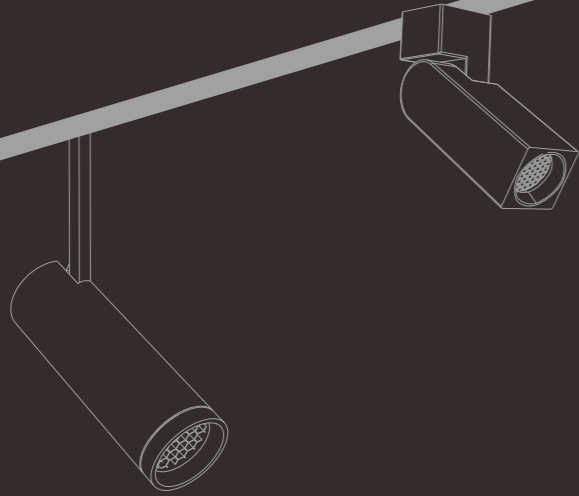

S potlight



350°

90°

产品尺寸(mm):

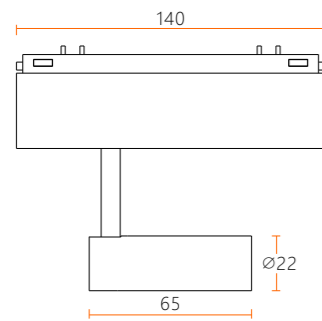

控制系统

- ON/OFF
- 0-10V
- DALI 调光控制系统
- 可控硅控制系统
- 其他调光控制系统

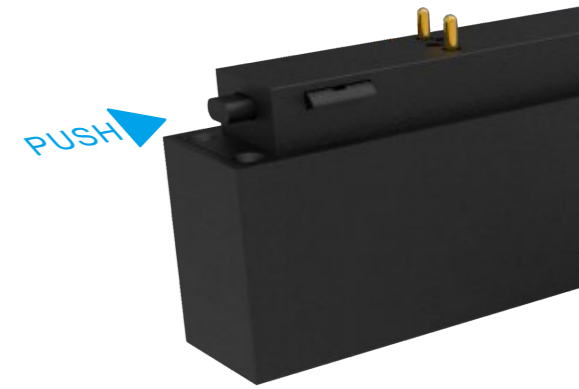

挤压两端机械按钮，将灯具嵌入轨道，松开即可固定灯具；磁吸+机械卡扣固定，灯具更牢固不易掉落。

22型射灯

光学参数

光束角	15°	24°																														
光通量	246.3 lm	166.6 lm																														
照度距离关系	<table border="1"> <thead> <tr> <th>h(m)</th> <th>E0°(lx)</th> <th>φ(m)</th> </tr> </thead> <tbody> <tr> <td>1.50</td> <td>773.66</td> <td>0.41</td> </tr> <tr> <td>2.25</td> <td>343.85</td> <td>0.61</td> </tr> <tr> <td>3.50</td> <td>142.10</td> <td>0.95</td> </tr> <tr> <td>4.00</td> <td>108.80</td> <td>1.08</td> </tr> </tbody> </table>	h(m)	E0°(lx)	φ(m)	1.50	773.66	0.41	2.25	343.85	0.61	3.50	142.10	0.95	4.00	108.80	1.08	<table border="1"> <thead> <tr> <th>h(m)</th> <th>E0°(lx)</th> <th>φ(m)</th> </tr> </thead> <tbody> <tr> <td>1.50</td> <td>328.86</td> <td>0.60</td> </tr> <tr> <td>2.25</td> <td>146.16</td> <td>0.90</td> </tr> <tr> <td>3.50</td> <td>60.40</td> <td>1.40</td> </tr> <tr> <td>4.00</td> <td>46.25</td> <td>1.60</td> </tr> </tbody> </table>	h(m)	E0°(lx)	φ(m)	1.50	328.86	0.60	2.25	146.16	0.90	3.50	60.40	1.40	4.00	46.25	1.60
h(m)	E0°(lx)	φ(m)																														
1.50	773.66	0.41																														
2.25	343.85	0.61																														
3.50	142.10	0.95																														
4.00	108.80	1.08																														
h(m)	E0°(lx)	φ(m)																														
1.50	328.86	0.60																														
2.25	146.16	0.90																														
3.50	60.40	1.40																														
4.00	46.25	1.60																														

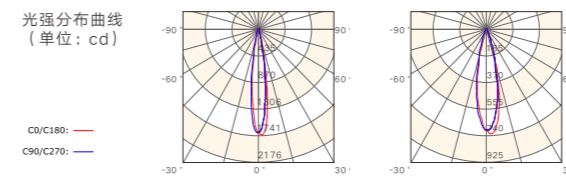

产品型号: SG-SD2265/3W
 产品尺寸: φ22*L65mm
 材 质: 6063铝
 外观颜色: 砂黑色/砂白色
 防护等级: IP20
 调 光: 支持
 光 源: Osram
 电 压: DC24V
 功 率: 3W
 色 温: 2700K/3000K/4000K
 CRI : ≥90
 光 束 角: 15°/24°

色温对比图例

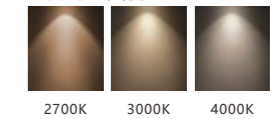



产品尺寸(mm):

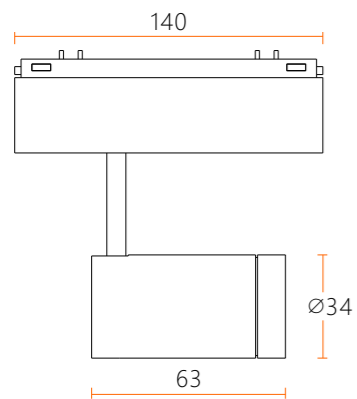

控制系统

- ON/OFF
- 0-10V
- DALI 调光控制系统
- 可控硅控制系统
- 其他调光控制系统



22型射灯

光学参数

光束角	15°	24°	38°
光通量	345.3 lm	403.8 lm	258.5 lm

照度距离关系			照度距离关系			照度距离关系		
h(m)	E0 ² (lx)	ø(m)	h(m)	E0 ² (lx)	ø(m)	h(m)	E0 ² (lx)	ø(m)
1.50	1018.54	0.56	1.50	740.50	0.57	1.50	196.43	1.16
2.25	452.69	0.84	2.25	329.11	0.86	2.25	87.30	1.75
3.50	187.08	1.30	3.50	136.01	1.33	3.50	36.08	2.72
4.00	143.23	1.48	4.00	104.13	1.52	4.00	27.62	3.11

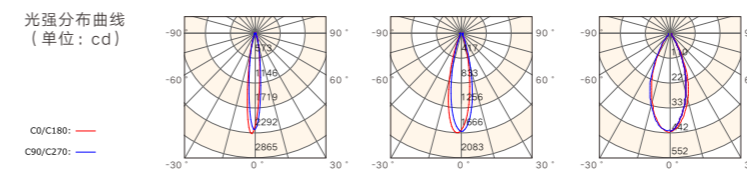

- 产品型号: SG-SD223463/5W
- 产品尺寸: φ34*L63mm
- 材 质: 6063铝
- 外观颜色: 砂黑色/砂白色
- 防护等级: IP20
- 调 光: 支持
- 光 源: Honourtek/Luminus
- 电 压: DC24V
- 功 率: 5W
- 色 温: 2700K/3000K/4000K
- CRI : ≥90
- 光 束 角: 15°/24°/38°

色温对比图例

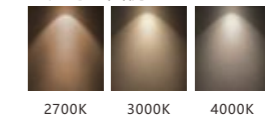



产品尺寸 (mm):

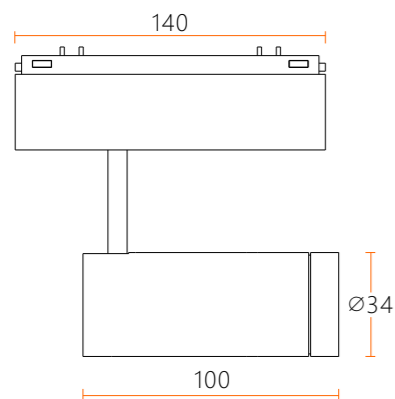

控制系统

- ON/OFF
- 0-10V
- DALI 调光控制系统
- 可控硅控制系统
- 其他调光控制系统

22系列轨道灯具模块



22型射灯

光学参数

光束角	15°	24°	38°
光通量	563.5lm	494.4 lm	339.7lm

照射距离关系	15°			24°			38°		
	h(m)	E0 ² (lx)	ø(m)	h(m)	E0 ² (lx)	ø(m)	h(m)	E0 ² (lx)	ø(m)
	1.50	1327.53	0.57	1.50	968.11	0.61	1.50	259.43	1.12
	2.25	590.01	0.86	2.25	430.27	0.92	2.25	115.3	1.68
	3.50	243.83	1.34	3.50	177.82	1.43	3.50	47.65	2.62
	4.00	186.68	1.53	4.00	136.14	1.63	4.00	36.48	2.99

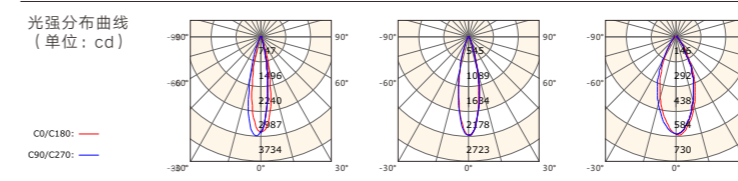

产品型号: SG-SD2234100/8W
 产品尺寸: φ34*L100mm
 材 质: 6063铝
 外观颜色: 砂黑色/砂白色
 防护等级: IP20
 调 光: 支持
 光 源: Honourtek/Luminus
 电 压: DC24V
 功 率: 8W
 色 温: 2700K/3000K/4000K
 CRI : ≥90
 光 束 角: 15°/24°/38°

色温对比图例

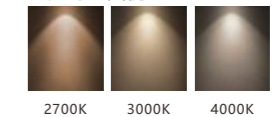

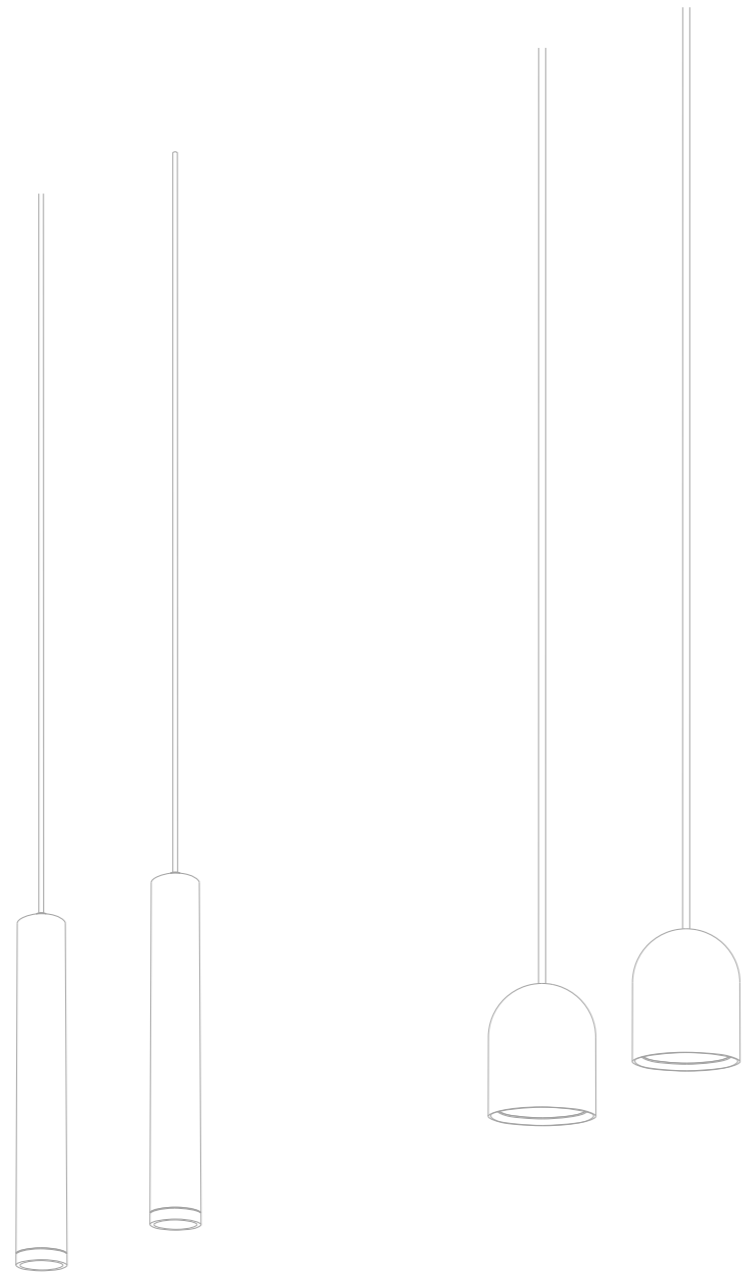

Dropline





产品尺寸(mm):

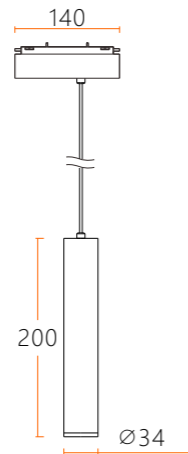

- 可调光
- 安装方便
- CRI
- 无频闪
- 高效节能
- 名师设计
- 环保材料

控制系统

- ON/OFF
- 0-10V
- DALI 调光控制系统
- 可控硅控制系统
- 其他调光控制系统

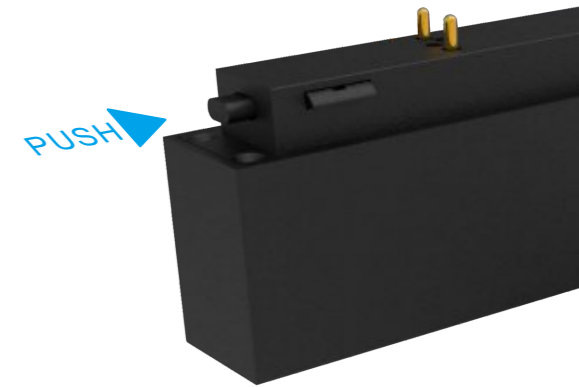

挤压两端机械按钮，将灯具嵌入轨道，松开即可固定灯具；磁吸+机械卡扣固定，灯具更牢固不易掉落。

22型吊线灯

光学参数

光束角	15°	24°	38°																																													
光通量	345.3 lm	403.8 lm	258.5 lm																																													
照度距离关系	<table border="1"> <thead> <tr> <th>h(m)</th> <th>E0²(lx)</th> <th>ø(m)</th> </tr> </thead> <tbody> <tr><td>1.50</td><td>1018.54</td><td>0.56</td></tr> <tr><td>2.25</td><td>452.69</td><td>0.84</td></tr> <tr><td>3.50</td><td>187.08</td><td>1.30</td></tr> <tr><td>4.00</td><td>143.23</td><td>1.48</td></tr> </tbody> </table>	h(m)	E0 ² (lx)	ø(m)	1.50	1018.54	0.56	2.25	452.69	0.84	3.50	187.08	1.30	4.00	143.23	1.48	<table border="1"> <thead> <tr> <th>h(m)</th> <th>E0²(lx)</th> <th>ø(m)</th> </tr> </thead> <tbody> <tr><td>1.50</td><td>740.50</td><td>0.57</td></tr> <tr><td>2.25</td><td>329.11</td><td>0.86</td></tr> <tr><td>3.50</td><td>136.01</td><td>1.33</td></tr> <tr><td>4.00</td><td>104.13</td><td>1.52</td></tr> </tbody> </table>	h(m)	E0 ² (lx)	ø(m)	1.50	740.50	0.57	2.25	329.11	0.86	3.50	136.01	1.33	4.00	104.13	1.52	<table border="1"> <thead> <tr> <th>h(m)</th> <th>E0²(lx)</th> <th>ø(m)</th> </tr> </thead> <tbody> <tr><td>1.50</td><td>196.43</td><td>1.16</td></tr> <tr><td>2.25</td><td>87.30</td><td>1.75</td></tr> <tr><td>3.50</td><td>36.08</td><td>2.72</td></tr> <tr><td>4.00</td><td>27.62</td><td>3.11</td></tr> </tbody> </table>	h(m)	E0 ² (lx)	ø(m)	1.50	196.43	1.16	2.25	87.30	1.75	3.50	36.08	2.72	4.00	27.62	3.11
h(m)	E0 ² (lx)	ø(m)																																														
1.50	1018.54	0.56																																														
2.25	452.69	0.84																																														
3.50	187.08	1.30																																														
4.00	143.23	1.48																																														
h(m)	E0 ² (lx)	ø(m)																																														
1.50	740.50	0.57																																														
2.25	329.11	0.86																																														
3.50	136.01	1.33																																														
4.00	104.13	1.52																																														
h(m)	E0 ² (lx)	ø(m)																																														
1.50	196.43	1.16																																														
2.25	87.30	1.75																																														
3.50	36.08	2.72																																														
4.00	27.62	3.11																																														

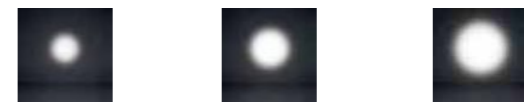
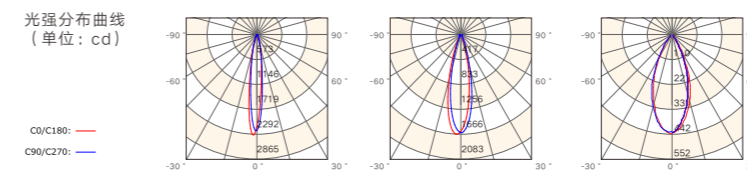

产品型号: SG-DXD2234200/5W
 产品尺寸: φ34*L200mm
 材 质: 6063铝
 外观颜色: 砂黑色/砂白色
 防护等级: IP20
 调 光: 支持
 光 源: Honourtek/Luminus
 电 压: DC24V
 功 率: 5W/8W/10W
 色 温: 2700K/3000K/4000K
 CRI : ≥90
 光 束 角: 15°/24°/38°

色温对比图例

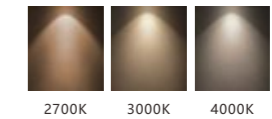



产品尺寸(mm):

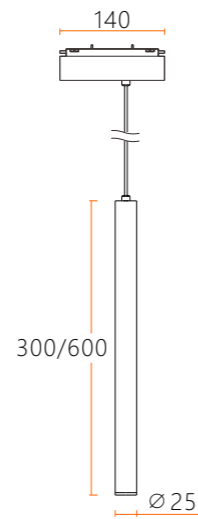

- 可调光
- 安装方便
- CRI
- 无频闪
- 高效节能
- 名师设计
- 环保材料

控制系统

- ON/OFF
- 0-10V
- DALI 调光控制系统
- 可控硅控制系统
- 其他调光控制系统



22型吊线灯

光学参数

光束角	38°															
光通量	346.6 lm															
照度距离关系	<table border="1"> <thead> <tr> <th>h(m)</th> <th>E0²(lx)</th> <th>φ(m)</th> </tr> </thead> <tbody> <tr> <td>1.50</td> <td>340.05</td> <td>1.06</td> </tr> <tr> <td>2.25</td> <td>151.13</td> <td>1.59</td> </tr> <tr> <td>3.50</td> <td>62.46</td> <td>2.48</td> </tr> <tr> <td>4.00</td> <td>47.82</td> <td>2.83</td> </tr> </tbody> </table>	h(m)	E0 ² (lx)	φ(m)	1.50	340.05	1.06	2.25	151.13	1.59	3.50	62.46	2.48	4.00	47.82	2.83
h(m)	E0 ² (lx)	φ(m)														
1.50	340.05	1.06														
2.25	151.13	1.59														
3.50	62.46	2.48														
4.00	47.82	2.83														

光强分布曲线
(单位: cd)

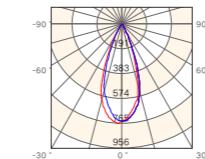

C0/C180: —
C90/C270: —

产品型号: SG-DXD2225300/5W
 产品尺寸: φ25*L300/L600mm
 材 质: 6063铝
 外观颜色: 砂黑色/砂白色
 防护等级: IP20
 调 光: 支持
 光 源: Honourtek/Luminus
 电 压: DC24V
 功 率: 5W
 色 温: 2700K/3000K/4000K
 CRI : ≥90
 光 束 角: 38°

色温对比图例

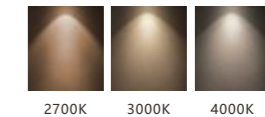

22型灵笼吊线灯

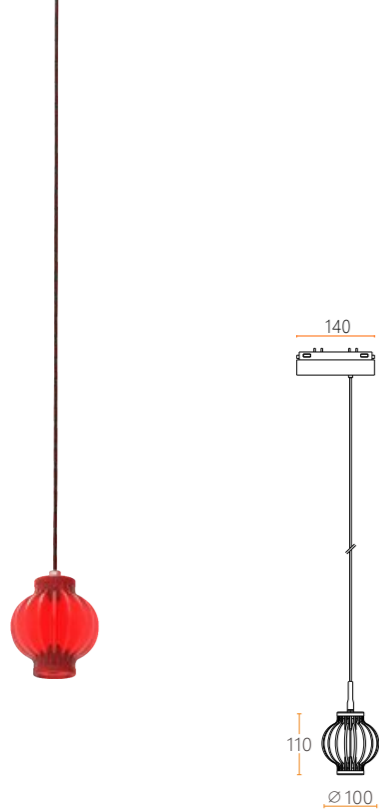

产品名称：22型磁吸组合照明灵笼吊线灯-小
 产品型号：SG-DXD22100110/3W
 产品尺寸：∅100*110mm
 材 质：亚克力+6063铝
 外观颜色：红色
 防护等级：IP20
 调 光：支持
 光 源：Honourtek/Luminus
 电 压：DC24V
 功 率：3W
 射灯色温：2700K/3000K/4000K
 CRI : ≥90
 光 束 角：24° /360°

22型灵笼吊线灯

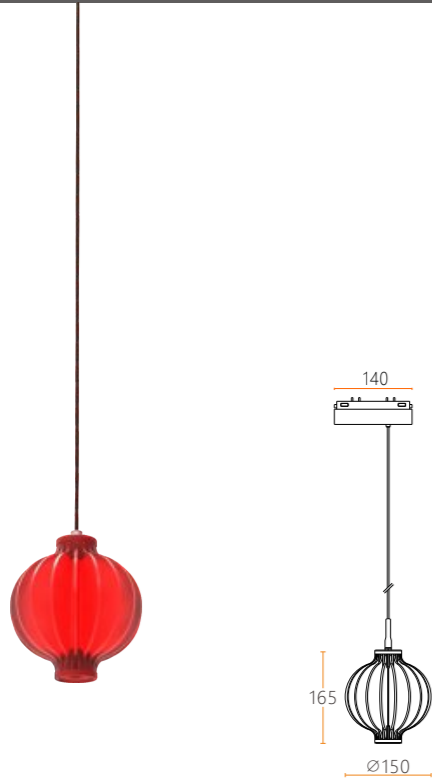

产品名称：22型磁吸组合照明灵笼吊线灯-中
 产品型号：SG-DXD22150165/4W
 产品尺寸：∅150*165mm
 材 质：亚克力+6063铝
 外观颜色：红色
 防护等级：IP20
 调 光：支持
 光 源：Honourtek/Luminus
 电 压：DC24V
 功 率：4W
 射灯色温：2700K/3000K/4000K
 CRI : ≥90
 光 束 角：24° /360°

22型灵笼吊线灯

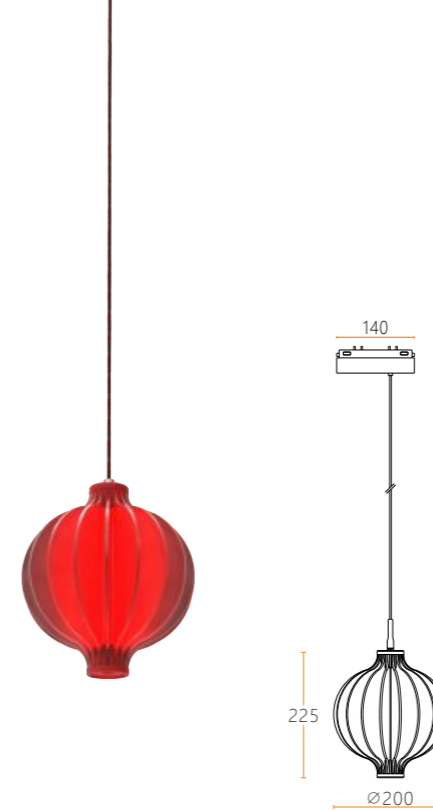

1.5W射灯
 光束角24°

产品名称：22型磁吸组合照明灵笼吊线灯-大
 产品型号：SG-DXD22200225/5W
 产品尺寸：∅200*225mm
 材 质：亚克力+6063铝
 外观颜色：红色
 防护等级：IP20
 调 光：支持
 光 源：Honourtek/Luminus
 电 压：DC24V
 功 率：5W
 射灯色温：2700K/3000K/4000K
 CRI : ≥90
 光 束 角：24° /360°

光学参数

光束角	24°																	
光通量	51.81 lm																	
照度距离关系	<table border="1"> <thead> <tr> <th>h(m)</th> <th>E0°(lx)</th> <th>φ(m)</th> </tr> </thead> <tbody> <tr> <td>1.50</td> <td>81.83</td> <td>0.61</td> </tr> <tr> <td>2.25</td> <td>43.03</td> <td>0.92</td> </tr> <tr> <td>3.50</td> <td>16.05</td> <td>1.42</td> </tr> <tr> <td>4.00</td> <td>9.94</td> <td>1.63</td> </tr> </tbody> </table>			h(m)	E0°(lx)	φ(m)	1.50	81.83	0.61	2.25	43.03	0.92	3.50	16.05	1.42	4.00	9.94	1.63
h(m)	E0°(lx)	φ(m)																
1.50	81.83	0.61																
2.25	43.03	0.92																
3.50	16.05	1.42																
4.00	9.94	1.63																
光强分布曲线 (单位：cd)																		



控制系统

- ON/OFF
- 0-10V
- DALI 调光控制系统
- 可控硅控制系统
- 其他调光控制系统

色温对比图例



sc combin[®] 三谷
照明



360° 氛围照明

射灯1.5W

D 灵笼吊线灯
ropline



22型苹果吊线灯-小

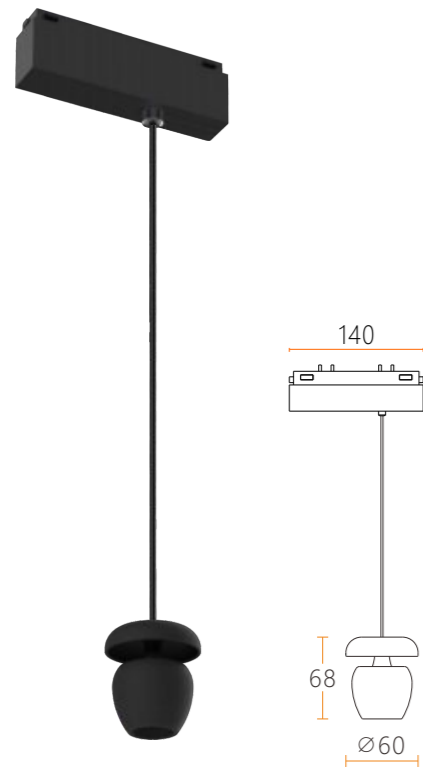

产品型号: SG-DXD226068/5W
 产品尺寸: $\varnothing 60 \times 68 \text{mm}$
 材 质: 6063铝
 外观颜色: 黑色/红色/墨绿色
 防护等级: IP20
 调 光: 支持
 光 源: Honourtek/Luminus
 电 压: DC24V
 功 率: 5W
 色 温: 2700K/3000K/4000K
 CRI : ≥ 90
 光 束 角: $15^\circ / 24^\circ / 38^\circ$

光学参数

光束角	15°	24°	38°
-----	-----	-----	-----

光通量	345.3 lm	403.8 lm	258.5 lm
-----	----------	----------	----------

15°			24°			38°		
h(m)	E0°(lx)	ø(m)	h(m)	E0°(lx)	ø(m)	h(m)	E0°(lx)	ø(m)
1.50	1018.54	0.56	1.50	740.50	0.57	1.50	196.43	1.16
2.25	452.69	0.84	2.25	329.11	0.86	2.25	87.30	1.75
3.50	187.08	1.30	3.50	136.01	1.33	3.50	36.08	2.72
4.00	143.23	1.48	4.00	104.13	1.52	4.00	27.62	3.11

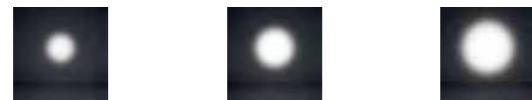
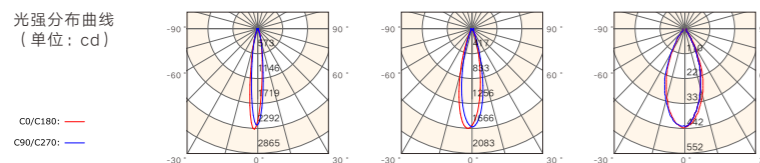

控制系统

- ON/OFF
- 0-10V
- DALI 调光控制系统
- 可控硅控制系统
- 其他调光控制系统

色温对比图例

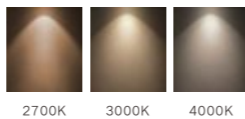

22型明苹果吊线灯-中

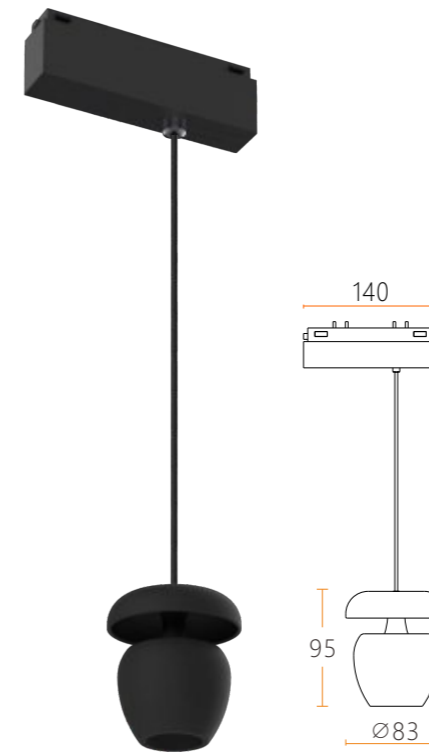

产品型号: SG-DXD228395/8W
 产品尺寸: $\varnothing 83 \times 95 \text{mm}$
 材 质: 6063铝
 外观颜色: 黑色/红色/墨绿色
 防护等级: IP20
 调 光: 支持
 光 源: Honourtek/Luminus
 电 压: DC24V
 功 率: 8W
 色 温: 2700K/3000K/4000K
 CRI : ≥ 90
 光 束 角: $15^\circ / 24^\circ / 38^\circ$

光学参数

光束角	15°	24°	38°
-----	-----	-----	-----

光通量	563.5lm	494.4 lm	339.7lm
-----	---------	----------	---------

15°			24°			38°		
h(m)	E0°(lx)	ø(m)	h(m)	E0°(lx)	ø(m)	h(m)	E0°(lx)	ø(m)
1.50	1327.53	0.57	1.50	968.11	0.61	1.50	259.43	1.12
2.25	590.01	0.86	2.25	430.27	0.92	2.25	115.3	1.68
3.50	243.83	1.34	3.50	177.82	1.43	3.50	47.65	2.62
4.00	186.68	1.53	4.00	136.14	1.63	4.00	36.48	2.99

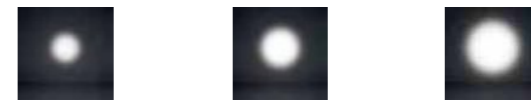
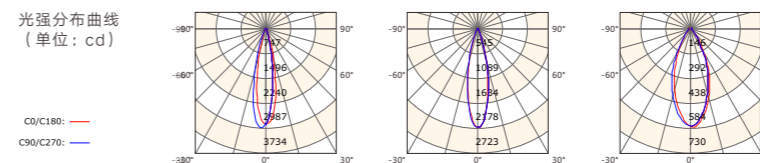

控制系统

- ON/OFF
- 0-10V
- DALI 调光控制系统
- 可控硅控制系统
- 其他调光控制系统

色温对比图例



22型侧发光圆球吊线灯

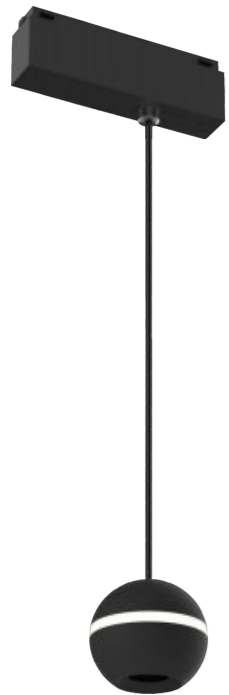

产品型号: SG-DXD227570/5W/A
 产品尺寸: $\varnothing 75 \times 70 \text{mm}$
 材 质: 6063铝
 外观颜色: 黑色/红色/墨绿色
 防护等级: IP20
 调 光: 支持
 光 源: Honourtek/Luminus
 电 压: DC24V
 功 率: 5W/8W
 色 温: 2700K/3000K/4000K
 CRI : ≥ 90
 光 束 角: $15^\circ / 24^\circ / 38^\circ$

22型圆球吊线灯



产品型号: SG-DXD227568/5W/B
 产品尺寸: $\varnothing 75 \times 68 \text{mm}$
 材 质: 6063铝
 外观颜色: 黑色/红色/墨绿色
 防护等级: IP20
 调 光: 支持
 光 源: Honourtek/Luminus
 电 压: DC24V
 功 率: 5W/8W
 色 温: 2700K/3000K/4000K
 CRI : ≥ 90
 光 束 角: $15^\circ / 24^\circ / 38^\circ$

22系列轨道灯具模块

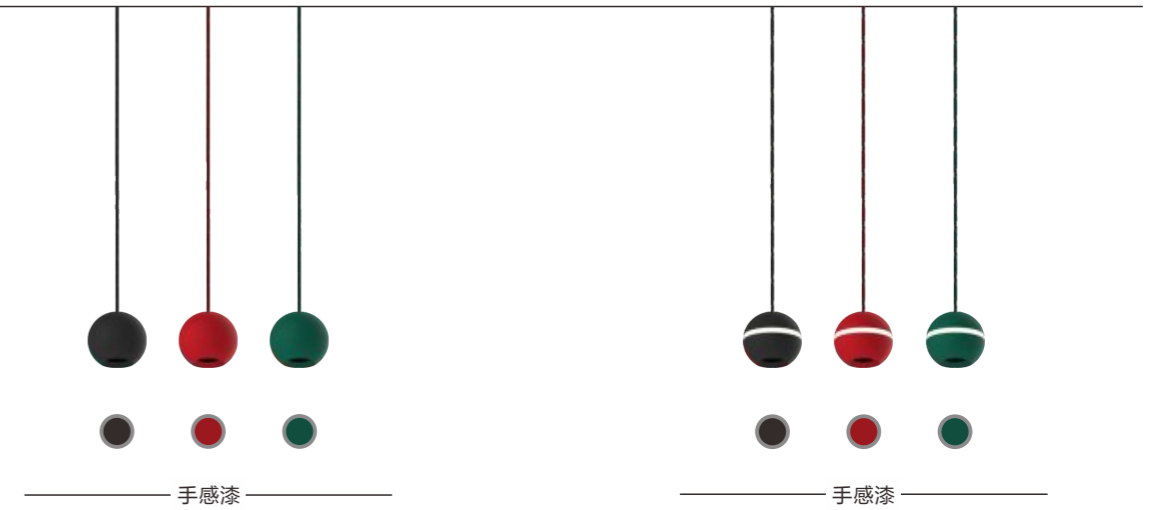

光学参数

光束角	15°	24°	38°																																													
光通量	345.3 lm	403.8 lm	258.5 lm																																													
照度距离关系	<table border="1"> <thead> <tr> <th>h(m)</th> <th>E0'(lx)</th> <th>ø(m)</th> </tr> </thead> <tbody> <tr><td>1.50</td><td>1018.54</td><td>0.56</td></tr> <tr><td>2.25</td><td>452.69</td><td>0.84</td></tr> <tr><td>3.50</td><td>187.08</td><td>1.30</td></tr> <tr><td>4.00</td><td>143.23</td><td>1.48</td></tr> </tbody> </table>	h(m)	E0'(lx)	ø(m)	1.50	1018.54	0.56	2.25	452.69	0.84	3.50	187.08	1.30	4.00	143.23	1.48	<table border="1"> <thead> <tr> <th>h(m)</th> <th>E0'(lx)</th> <th>ø(m)</th> </tr> </thead> <tbody> <tr><td>1.50</td><td>740.50</td><td>0.57</td></tr> <tr><td>2.25</td><td>329.11</td><td>0.86</td></tr> <tr><td>3.50</td><td>136.01</td><td>1.33</td></tr> <tr><td>4.00</td><td>104.13</td><td>1.52</td></tr> </tbody> </table>	h(m)	E0'(lx)	ø(m)	1.50	740.50	0.57	2.25	329.11	0.86	3.50	136.01	1.33	4.00	104.13	1.52	<table border="1"> <thead> <tr> <th>h(m)</th> <th>E0'(lx)</th> <th>ø(m)</th> </tr> </thead> <tbody> <tr><td>1.50</td><td>196.43</td><td>1.16</td></tr> <tr><td>2.25</td><td>87.30</td><td>1.75</td></tr> <tr><td>3.50</td><td>36.08</td><td>2.72</td></tr> <tr><td>4.00</td><td>27.62</td><td>3.11</td></tr> </tbody> </table>	h(m)	E0'(lx)	ø(m)	1.50	196.43	1.16	2.25	87.30	1.75	3.50	36.08	2.72	4.00	27.62	3.11
h(m)	E0'(lx)	ø(m)																																														
1.50	1018.54	0.56																																														
2.25	452.69	0.84																																														
3.50	187.08	1.30																																														
4.00	143.23	1.48																																														
h(m)	E0'(lx)	ø(m)																																														
1.50	740.50	0.57																																														
2.25	329.11	0.86																																														
3.50	136.01	1.33																																														
4.00	104.13	1.52																																														
h(m)	E0'(lx)	ø(m)																																														
1.50	196.43	1.16																																														
2.25	87.30	1.75																																														
3.50	36.08	2.72																																														
4.00	27.62	3.11																																														

光强分布曲线
(单位: cd)

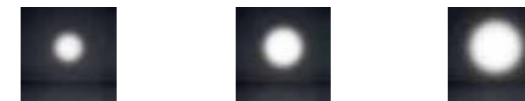
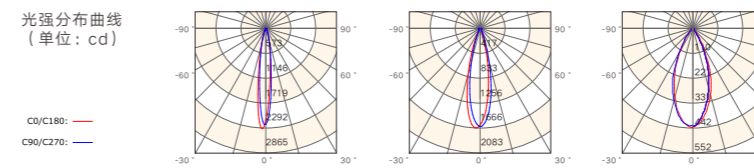

- 可调光
- 安装方便
- CRI 高显指
- 环保材料
- 无频闪
- 高效节能
- 名师设计

控制系统

- ON/OFF
- 0-10V
- DALI 调光控制系统
- 可控硅控制系统
- 其他调光控制系统

色温对比图例

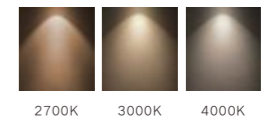



喷粉色 ● ○ ● ● 氧化色 ● ● ● ●

产品尺寸(mm):

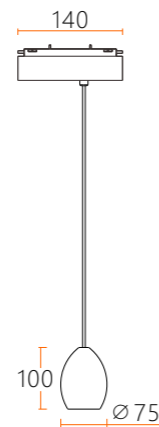

控制系统

- ON/OFF
- 0-10V
- DALI 调光控制系统
- 可控硅控制系统
- 其他调光控制系统



22型吊线灯 (大锐曲)

光学参数

光束角	15°	24°	38°
-----	-----	-----	-----

光通量	406.7 lm	369.5 lm	258.5 lm
-----	----------	----------	----------

照度距离关系			照度距离关系			照度距离关系		
h(m)	E0 ² (lx)	ø(m)	h(m)	E0 ² (lx)	ø(m)	h(m)	E0 ² (lx)	ø(m)
1.50	1392.28	0.43	1.50	685.09	0.64	1.50	196.43	1.16
2.25	618.79	0.64	2.25	304.48	0.95	2.25	87.30	1.75
3.50	255.72	1.00	3.50	125.83	1.48	3.50	36.08	2.72
4.00	195.79	1.15	4.00	96.34	1.69	4.00	27.62	3.11

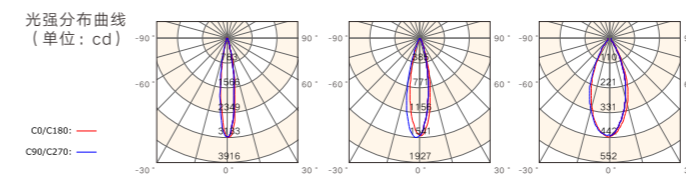

产品型号: SG-DXD2275100/5W
 产品尺寸: ϕ 75*100mm
 材质: 6063铝
 外观颜色: 砂黑/砂白/军绿/灰色/金色/红色/玫瑰金/蓝色
 防护等级: IP20
 调光: 支持
 光源: Honourtek/Luminus
 电压: DC24V
 功率: 5W/8W
 色温: 2700K/3000K/4000K
 CRI: \geq 90
 光束角: 15°/24°/38°

22型吊线灯 (麦语)

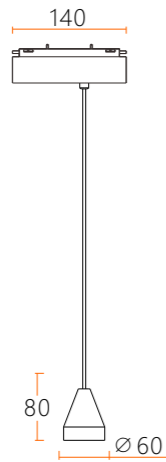
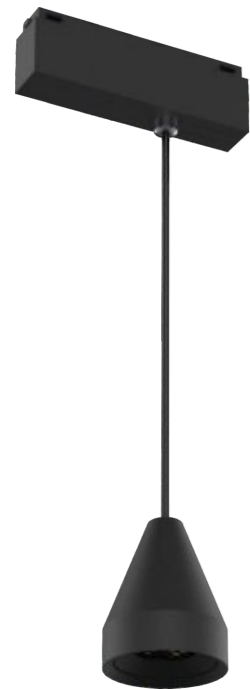

产品型号: SG-DXD226080/5W/A
 产品尺寸: $\phi 60 \times 80 \text{mm}$
 材 质: 6063铝
 外观颜色: 砂黑/砂白/军绿/灰色/金色/红色/玫瑰金/蓝色
 防护等级: IP20
 调 光: 支持
 光 源: Honourtek/Luminus
 电 压: DC24V
 功 率: 5W
 色 温: 2700K/3000K/4000K
 CRI : ≥ 90
 光 束 角: $15^\circ / 24^\circ / 38^\circ$

22型吊线灯 (朵意)

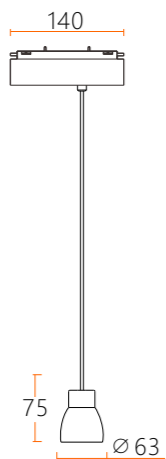

产品型号: SG-DXD226375/5W/B
 产品尺寸: $\phi 63 \times 75 \text{mm}$
 材 质: 6063铝
 外观颜色: 砂黑/砂白/军绿/灰色/金色/红色/玫瑰金/蓝色
 防护等级: IP20
 调 光: 支持
 光 源: Honourtek/Luminus
 电 压: DC24V
 功 率: 5W
 色 温: 2700K/3000K/4000K
 CRI : ≥ 90
 光 束 角: $15^\circ / 24^\circ / 38^\circ$

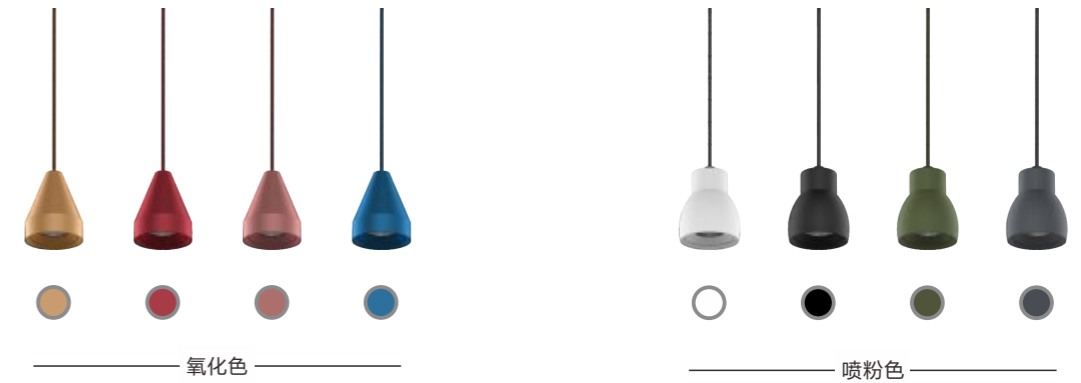

光学参数

光束角	15°	24°	38°
光通量	406.7 lm	369.5 lm	258.5 lm

照度距离关系	15°			24°			38°		
	h(m)	E0 ² (lx)	ø(m)	h(m)	E0 ² (lx)	ø(m)	h(m)	E0 ² (lx)	ø(m)
	1.50	1392.28	0.43	1.50	685.09	0.64	1.50	196.43	1.16
	2.25	618.79	0.64	2.25	304.48	0.95	2.25	87.30	1.75
	3.50	255.72	1.00	3.50	125.83	1.48	3.50	36.08	2.72
	4.00	195.79	1.15	4.00	96.34	1.69	4.00	27.62	3.11

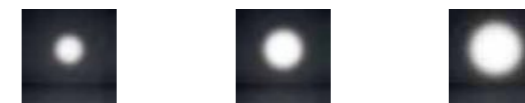
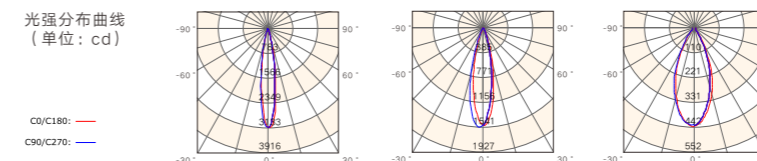

控制系统

- ON/OFF
- 0-10V
- DALI 调光控制系统
- 可控硅控制系统
- 其他调光控制系统

色温对比图例

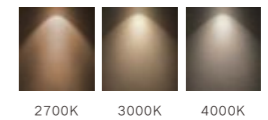

22型照明吊线灯 (舒意)

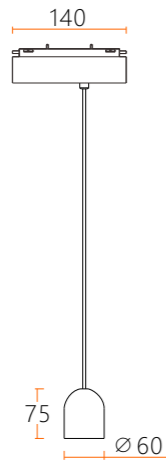

产品型号: SG-DXD226075/5W/C
 产品尺寸: $\phi 60 \times 75$ mm
 材 质: 6063铝
 外观颜色: 砂黑/砂白/军绿/灰色/金色/红色/玫瑰金/蓝色
 防护等级: IP20
 调 光: 支持
 光 源: Honourtek/Luminus
 电 压: DC24V
 功 率: 5W
 色 温: 2700K/3000K/4000K
 CRI : ≥ 90
 光 束 角: $15^\circ / 24^\circ / 38^\circ$

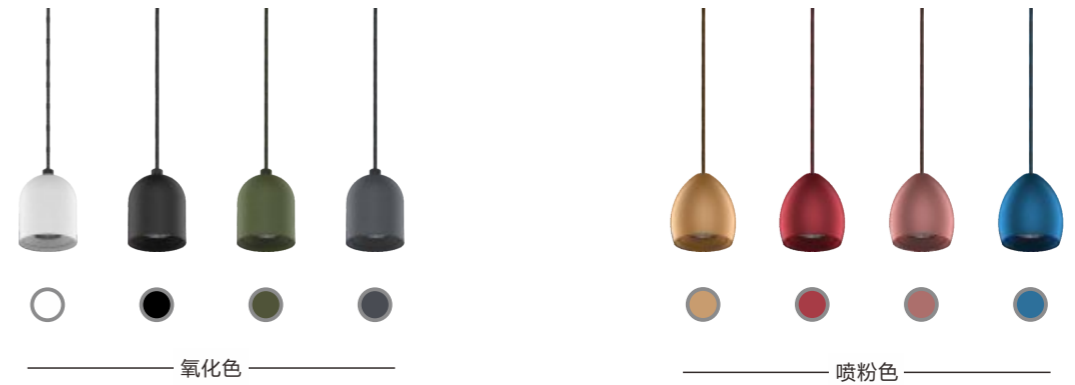

22型吊线灯 (锐曲)

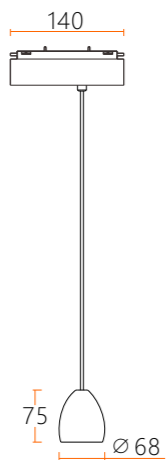

产品型号: SG-DXD226875/5W/D
 产品尺寸: $\phi 68 \times 75$ mm
 材 质: 6063铝
 外观颜色: 砂黑/砂白/军绿/灰色/金色/红色/玫瑰金/蓝色
 防护等级: IP20
 调 光: 支持
 光 源: Honourtek/Luminus
 电 压: DC24V
 功 率: 5W
 色 温: 2700K/3000K/4000K
 CRI : ≥ 90
 光 束 角: $15^\circ / 24^\circ / 38^\circ$

光学参数

光束角	15°	24°	38°
光通量	406.7 lm	369.5 lm	258.5 lm

照度距离关系	15°			24°			38°		
	h(m)	E0 ² (lx)	ϕ (m)	h(m)	E0 ² (lx)	ϕ (m)	h(m)	E0 ² (lx)	ϕ (m)
	1.50	1392.28	0.43	1.50	685.09	0.64	1.50	196.43	1.16
	2.25	618.79	0.64	2.25	304.48	0.95	2.25	87.30	1.75
	3.50	255.72	1.00	3.50	125.83	1.48	3.50	36.08	2.72
	4.00	195.79	1.15	4.00	96.34	1.69	4.00	27.62	3.11

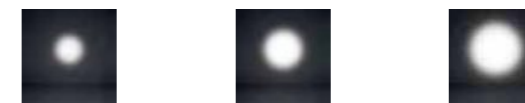
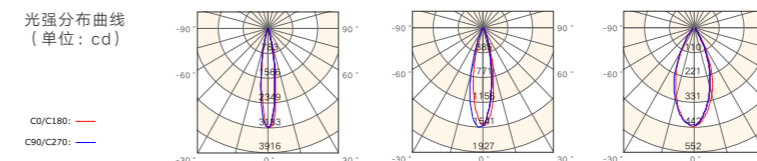

控制系统

- ON/OFF
- 0-10V
- DALI 调光控制系统
- 可控硅控制系统
- 其他调光控制系统

色温对比图例



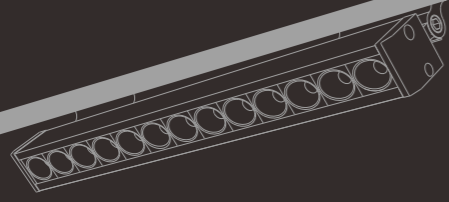

G rille



产品尺寸(mm):

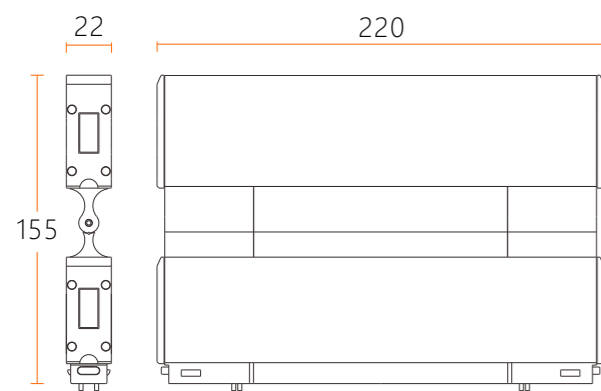

控制系统

- ON/OFF
- 0-10V
- DALI 调光控制系统
- 可控硅控制系统
- 其他调光控制系统

22型专业版180度可调格栅线性灯

光学参数

光束角	25°
光通量	474.7 lm

照度距离关系	h(m)	E0°(lx)	ø(m)
	1.50	992.29	0.54
	2.25	441.02	0.81
	3.50	182.26	1.26
	4.00	139.54	1.44

光强分布曲线
(单位: cd)

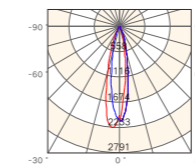

C0/C180: —
C90/C270: —

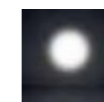

- 产品型号: SG-GSD22155/L220/T12W/G
- 产品尺寸: L220*W22*H155mm
- 材 质: 6063铝
- 外观颜色: 砂黑色/砂白色
- 防护等级: IP20
- 调 光: 支持
- 光 源: Osram
- 电 压: DC24V
- 功 率: 12W
- 色 温: 2700K/3000K/4000K
- CRI : ≥90
- 光 束 角: 25°

色温对比图例





挤压两端机械按钮，将灯具嵌入轨道，松开即可固定灯具；磁吸+机械卡扣固定，灯具更牢固不易掉落。

产品尺寸(mm):



控制系统

- ON/OFF
- 0-10V
- DALI 调光控制系统
- 可控硅控制系统
- 其他调光控制系统

22型专业版照明格栅线性灯

光学参数

光束角 25°

光通量 474.7 lm

照度距离关系

h(m)	E0 ² (lx)	ø(m)
1.50	992.29	0.54
2.25	441.02	0.81
3.50	182.26	1.26
4.00	139.54	1.44

光强分布曲线
(单位: cd)

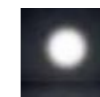
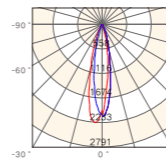

产品型号: SG-GSD2265/L220/12W/G
 产品尺寸: L220*W22*H65mm
 材 质: 6063铝
 外观颜色: 砂黑色/砂白色
 防护等级: IP20
 调 光: 支持
 光 源: Osram
 电 压: DC24V
 功 率: 12W
 色 温: 2700K/3000K/4000K
 CRI : ≥90
 光 束 角: 25°

色温对比图例

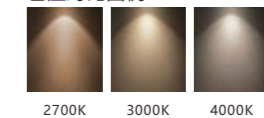

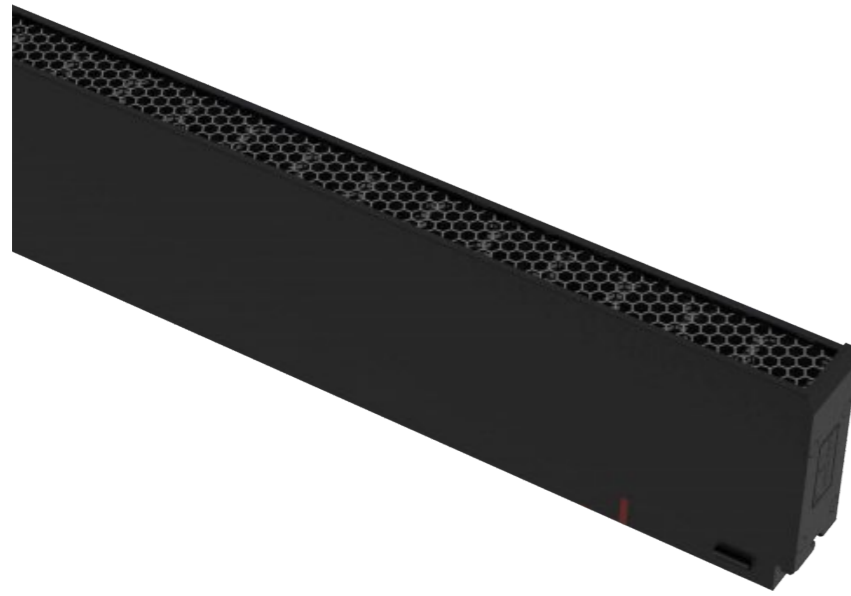

产品尺寸(mm):

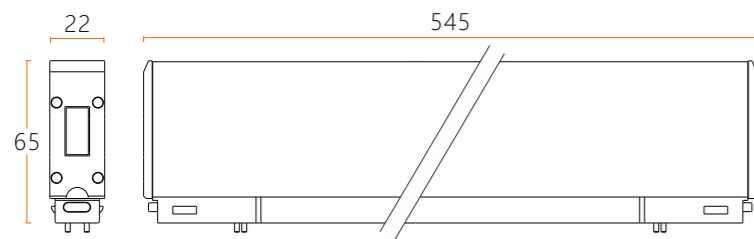

控制系统

- ON/OFF
- 0-10V
- DALI 调光控制系统
- 可控硅控制系统
- 其他调光控制系统

22型专业版照明格栅线性灯

光学参数

光束角 25°

光通量 965.8 lm

照度距离关系

h(m)	E0 ² (lx)	ø(m)
1.50	2502.21	0.53
2.25	1112.10	0.80
3.50	459.59	1.25
4.00	351.87	1.43

光强分布曲线
(单位: cd)

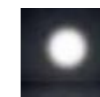
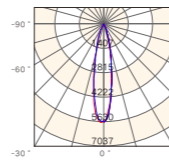

产品型号: SG-GSD2265/L545/25W/G

产品尺寸: L545*W22*H65mm

材 质: 6063铝

外观颜色: 砂黑色/砂白色

防护等级: IP20

调 光: 支持

光 源: Osram

电 压: DC24V

功 率: 25W

色 温: 2700K/3000K/4000K

CRI : ≥90

光 束 角: 25°

色温对比图例

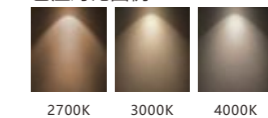



Linear



将磁吸灯具直接嵌入相应的轨道，略微用力挤压灯具，伸缩玻璃珠自动卡主轨道；磁吸+机械卡扣固定，灯具更牢固不易掉落。

产品尺寸(mm):

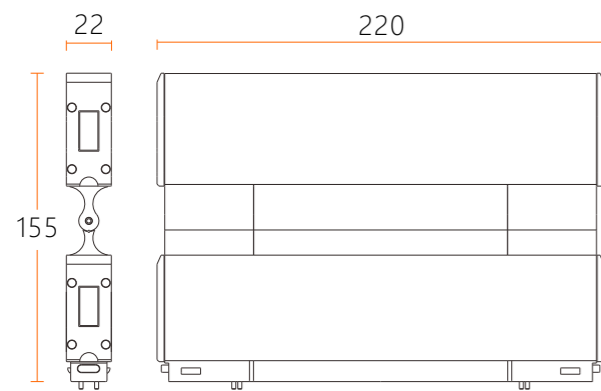

控制系统

- ON/OFF
- 0-10V
- DALI 调光控制系统
- 可控硅控制系统
- 其他调光控制系统

22型专业版180度可调平面发光线性灯

光学参数

光束角 100°

光通量 167.1 lm

照度距离关系

h(m)	E0 ² (lx)	ø(m)
1.50	30.04	3.64
2.25	13.35	5.46
3.50	5.52	8.50
4.00	4.22	9.72

光强分布曲线 (单位: cd)

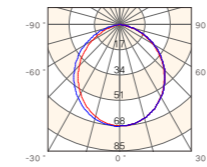

C0/C180: —
C90/C270: —



产品型号: SG-PMD22155/L247/T8W/G

产品尺寸: L247*W22*H155mm

材质: 6063铝

外观颜色: 砂黑色/砂白色

防护等级: IP20

调光: 支持

光源: Osram

电压: DC24V

功率: 8W

色温: 2700K/3000K/4000K

CRI: ≥90

光束角: 100°

色温对比图例



2700K 3000K 4000K

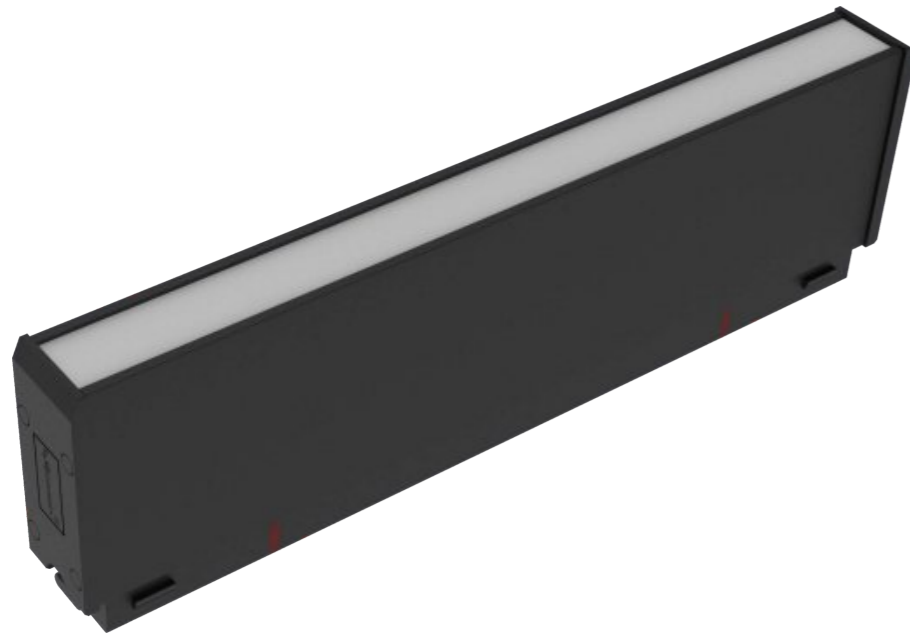

挤压两端机械按钮，将灯具嵌入轨道，松开即可固定灯具；磁吸+机械卡扣固定，灯具更牢固不易掉落。

产品尺寸(mm):

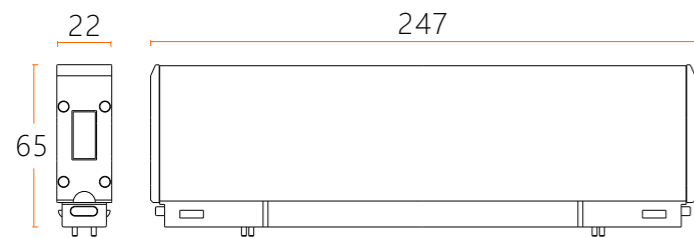

控制系统

- ON/OFF
- 0-10V
- DALI 调光控制系统
- 可控硅控制系统
- 其他调光控制系统

22型专业版平面发光线性灯

光学参数

光束角 100°

光通量 167.1 lm

照度距离关系

h(m)	E0 ² (lx)	ø(m)
1.50	30.04	3.64
2.25	13.35	5.46
3.50	5.52	8.50
4.00	4.22	9.72

光强分布曲线
(单位: cd)

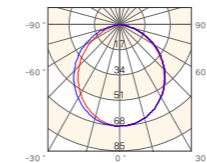

C0/C180: —
C90/C270: —



产品型号: SG-PMD2265/L247/8W/G
 产品尺寸: L247*W22*H65mm
 材质: 6063铝
 外观颜色: 砂黑色/砂白色
 防护等级: IP20
 调光: 支持
 光源: Osram
 电压: DC24V
 功率: 8W
 色温: 2700K/3000K/4000K
 CRI: ≥90
 光束角: 100°

色温对比图例



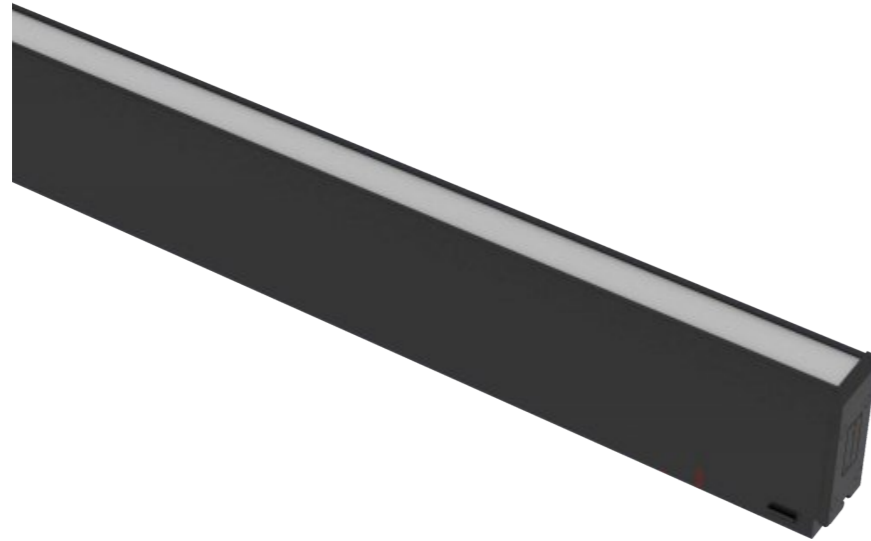

产品尺寸(mm):

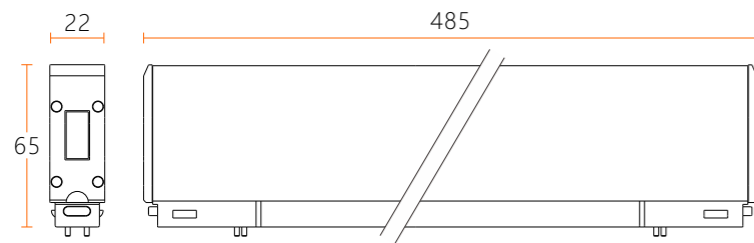

控制系统

- ON/OFF
- 0-10V
- DALI 调光控制系统
- 可控硅控制系统
- 其他调光控制系统

22型专业版平面发光线性灯

光学参数

光束角 100°

光通量 353.0 lm

照度距离关系

h(m)	E0 ² (lx)	φ(m)
1.50	62.15	3.72
2.25	27.62	5.57
3.50	11.42	8.67
4.00	8.74	9.91

光强分布曲线
(单位: cd)

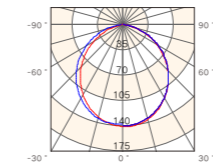

产品型号: SG-PMD2265/L485/16W/G
 产品尺寸: L485*W22*H65MM
 材质: 6063铝
 外观颜色: 砂黑色/砂白色
 防护等级: IP20
 调光: 支持
 光源: Osram
 电压: DC24V
 功率: 16W
 色温: 2700K/3000K/4000K
 CRI: ≥90
 光束角: 100°

色温对比图例

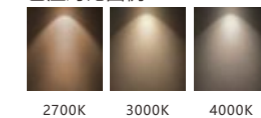





广东三谷照明科技有限公司

Guangdong Sangu Lighting Technology Co., Ltd

服务热线：0760-88752042

招商热线：13346496970 13425587944

地址：广东省中山市横栏镇茂辉工业区富横西路金盛工业园B栋